

HEALTHMARK

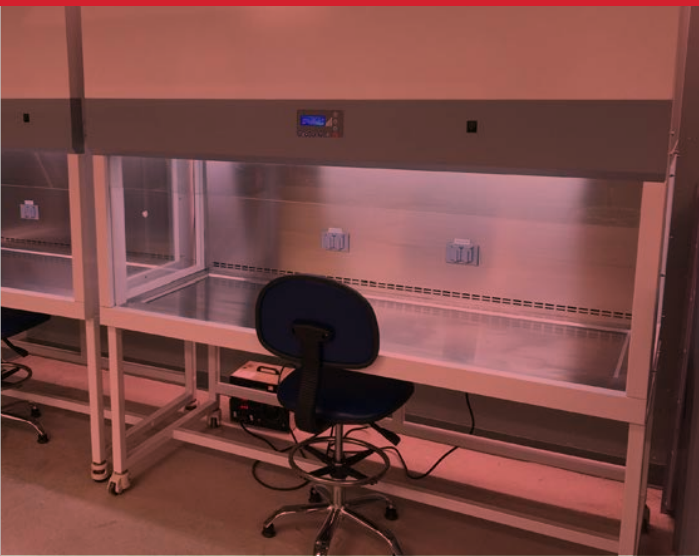

CATALOGUE



PHARMACY PRODUCTS AND SOLUTIONS



- MEDICATION PACKAGING AND DELIVERY SYSTEMS
- IV ADMIXTURE AND PREFILLED SYRINGES
- NAPRA COMPLIANT PRODUCTS
- PHARMACY AUTOMATION

RICHARDS

WWW.HEALTHMARK.CA

TABLE OF CONTENTS

Cleanroom and Compounding Equipment	4
Protective Apparel	8
IV Admixture Preparation	14
Quality and Contamination Control	27
Medication Packaging and Automation	39
Inventory, Delivery, and Safety Systems	60
Prefilled Syringes and Oral Unit-Dose Products	67
NAPRA Index	70
Categories Index	71

LEGEND



Cost-Effectiveness



Accuracy



Reliability



Efficiency



Safety



NAPRA Compliant



Safe for Chemotherapy



CLEANROOM

MODULAR CLEAN ROOM SYSTEMS

DFMZ PharmaMod 1.5 797 or Foamed in Place (FIP)

For compounding pharmacies and GMP compliant compounding facilities. Completely customizable to meet your environments and business needs while achieving NAPRA, USP <797> and <800>, or GMP standards.

- Heavy-duty, anodized, extruded aluminum frame
- Ceiling height up to 16 feet, sliding/swing door, gauge panels
- Solid white polypropylene and clear acrylic inserts



Design-Aire HEPA-filter fan modules



Custom design that fits particular space and process flow



Gauge panels complete with room pressure monitoring and light switches





MISTERIUM® Modular Cleanroom System

Grifols Misterium® modular cleanroom system offers significant financial and performance advantages over traditional cleanroom solutions.

Misterium is designed to meet the demands of the most stringent medical and aseptic environments. As a result, it is the solution of choice by many biomed, life science, biotech, medical device, nutraceutical, and pharmaceutical facilities.

- Modular design facilitates efficient installation and can be customized to fit any size space
- Flush ceiling system with wide hangers allows easy access to mechanical systems without disrupting the cleanroom
- Interior wall panels attach flush to ceiling panel surfaces
- Studless utility and liner wall options
- Aluminum honeycomb panel core
- Antimicrobial uPVC surfaces, coves, and chemically cold-welded seams
- Virtually flush seams for effective sanitation, wash-down, and fumigation
- Multiple flush door, window, and access openings, as well as various hardware options

PHARMACYKEEPER Pharmacy Software Applications

The PharmacyKeeper portfolio of products is a web-based application for improving key pharmacy operational processes and assisting organizations in becoming NAPRA compliant.

A scalable suite of solutions providing IV workflow and camera verification, activities, and training management.

Expertise focused on helping hospital and centralized compounding pharmacies gain strategic, sustainable control of their IV compounding environments.



Defined compounding processes that include barcode validation and remote verification



Improved communication and reduced cleanroom traffic and paper documentation



600 000 activities managed per month
2 million doses processed per month
45% reduction in medication turnaround time

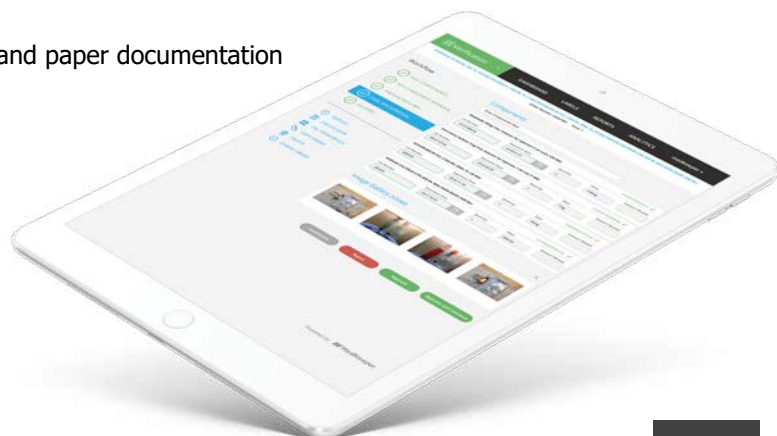



HOODS

KIRO® ONCOLOGY

Automated Compounding for Intravenous Oncology Treatments

KIRO® Oncology is the next-generation system for compounding of sterile preparations of oncology drugs, including chemotherapy and biologicals.

- Two robotic arms perform separate tasks simultaneously
- Self-cleaning for decontamination of hazardous chemicals
- Syringes, final containers, and drug vials from different manufacturers can be used simultaneously
- Lean design minimizes the movement of disposables in the compounding area



Protects from repetitive stress injuries and from exposure to hazardous drugs. Opens only for loading and unloading, and is closed during the entire compounding and cleaning processes



Performs gravimetric controls at each step of the compounding process and releases final products based on their accuracy to the prescribed dose



Can prepare both patient-specific and small batches using liquid or lyophilized drugs



Regulatory Compliance

KIRO® Oncology helps in compliance with USP, GMP, and NAPRA regulations by standardizing aseptic compounding procedures, facilitating personnel and process qualification, and minimizing risks when preparing hazardous admixtures.

FUNCTIONS	SPECIFICATIONS
DIMENSIONS	6.7' (W) X 3.7' (D) X 7.2' (H)
MINIMUM CLEARANCE	9.8' (W) X 8.2' (D) X 8.2' (H)
WEIGHT	1200KG
MINIMUM FLOOR LOAD RATING	200 KG/M ²
AIRFLOW RATE	400 M ³ /H
POWER	230 VAC ± 10%, 50HZ, 3KVA, 13 A (120 VAC ±10%, 60HZ, 3KVA, 25 A)
ELECTRICAL SAFETY	UL LISTING MARK PER IEC 61010 AND EMC CERTIFICATION PER IEC 61326-1
OTHER	ETHERNET PORT

LAMINAR AIR FLOW HOODS

Horizontal or vertical

VCM series Vertical Laminar Air Flow Hoods or HCM series Horizontal Laminar Air Flow Hoods create the ideal environment for excellent product protection, where particulates are not harmful to the operator, with multiple sizes to choose from.

- Fluorescent task lighting, sliding face shield
- Fixed or hydraulic base frames available
- Narrow profile, plug-and-play design
- Vertical LAFH in 4' or 6' lengths



NXT COMPOUNDING EXTRACTION HOOD

Fume, particulate and vapour extraction enclosure

NXT Compounding Extraction Hood provides the highest level of operator and environment protection from harmful contaminants while weighing non-sterile powders and compounds. Multiple filtration options available to meet your non-sterile compounding needs. Dual HEPA, External Exhausted, and Carbon filtration are all available.

- Operator protection
- Particulate filtration and corrosion resistant
- Independent operation

MINI VERTICAL LAMINAR FLOW HOOD

Clean air in a unique small size

DFMZ's VBM-200 Mini Vertical Laminar Flow Hood is built to provide clean air just about anywhere. Its unique size and quality make it a great addition to limited lab spaces.

- Minimum ISO 5 (Class 100) conditions
- Full-featured unit in a portable size



High Efficiency Particulate Air (HEPA) filter, rated at 99.999% efficient at 0.3µ

PRODUCT #	DESCRIPTION	QTY
DF-VBM200	MINI VERTICAL LAMINAR HOOD	EACH

FUNCTIONS	SPECIFICATIONS
WORK ZONE DIMENSIONS	19.0' (W) X 13.4' (D) x 14.5' (H)
EXTERNAL DIMENSIONS	21.5' (W) X 18.1' (D) x 27.5' (H)
WEIGHT	57KG





PROTECTIVE APPAREL

COMPOUNDING PERSONAL PROTECTION EQUIPMENT (PPE)

NON-HAZARDOUS COMPOUNDING (PPE)

GLOVES

Our gloves are latex and powder free to meet cleanroom requirements.

- Sterile and non-sterile options available
- Polychloroprene, nitrile, or neoprene formulations

FROCKS AND GOWNS FOR IV PREPARATION

These frocks and gowns are designed for cleanroom environments.

- Breathable, fluid resistant, low lint
- Sizes up to 10X available, for full coverage and flexibility
- Choice of lowest cost, lightweight, or superior style with thumb loops



Products manufactured from low-linting fabrics and with clean packaging to eliminate the hazards of airborne contaminants

COVERALLS

Tested against permeation standard ASTM F739-12 (for maximum chemo protection the coverall is made to be used combined with BioClean-C apron on next page)

- Sterile coveralls and accessories are also available.

SHOE COVERS AND BOOTIES

- Regular/Large fits up to men's size 12; X-Large up to size 15



CritiGear™ Frock



PRODUCT INDEX

PRODUCT #	DESCRIPTION	QTY
NI-S-BFAP #SIZE	FUSION™, STERILE, GREEN POLYCHLOROPRENE, HAND SPECIFIC 5.0 TO 10.0	200PRS/CS
ML-484 #SIZE	SENSICARE, STERILE, VINYL, FOR IV PREPARATION, SMALL TO LARGE	200PRS/CS
ML-MSG60 #SIZE	NEOLON®2G, STERILE, NEOPRENE, HAND SPECIFIC 6.0 TO 8.5	200PRS/CS
ML-MDS-70 #SIZE	SENSICARE SILK®, NON-STERILE, NITRILE, FOR IV PREPARATION, SMALL TO X-LARGE	2000EA/CS

PRODUCT #	DESCRIPTION	QTY
CN-HCGA0002	CRITIGEAR™, NON-STERILE, WHITE, CLEANROOM FROCK, X-SMALL (10/PACK)	30/CS
CN-HCGA0012	CRITIGEAR™, NON-STERILE, WHITE, CLEANROOM FROCK, SMALL (10/PACK)	30/CS
CN-HCGA0022	CRITIGEAR™, NON-STERILE, WHITE, CLEANROOM FROCK, MEDIUM (10/PACK)	30/CS
CN-HCGA0032	CRITIGEAR™, NON-STERILE, WHITE, CLEANROOM FROCK, LARGE (10/PACK)	30/CS
CN-HCGA0042	CRITIGEAR™, NON-STERILE, WHITE, CLEANROOM FROCK, X-LARGE (10/PACK)	30/CS
CN-HCGA0052	CRITIGEAR™, NON-STERILE, WHITE, CLEANROOM FROCK, 2X-LARGE (10/PACK)	30/CS
CN-HCGA0062	CRITIGEAR™, NON-STERILE, WHITE, CLEANROOM FROCK, 3X-LARGE (10/PACK)	30/CS
CN-HCGA0072	CRITIGEAR™, NON-STERILE, WHITE, CLEANROOM FROCK, 4X-LARGE (10/PACK)	30/CS
CN-HCGA0082	CRITIGEAR™, NON-STERILE, WHITE, CLEANROOM FROCK, 5X-LARGE (10/PACK)	30/CS
ML-NON27SMS2	NON-STERILE, YELLOW, IV PREP GOWN, SIDE NECK TIE, REG (10/PACK)	100/CS
ML-NON27SMS2XL	NON-STERILE, YELLOW, IV PREP GOWN, SIDE NECK TIE, X-LARGE (10/PACK)	100/CS
HC-CST200U	NON-STERILE, BARRIER GOWN, UNI-SIZE	25/CS
HC-CST200X	NON-STERILE, BARRIER GOWN, X-LARGE	25/CS
HC-CST210	NON-STERILE, BARRIER GOWN, UNI-SIZE	25/CS
HC-CST210X	NON-STERILE, BARRIER GOWN, X-LARGE	25/CS

PRODUCT #	DESCRIPTION	QTY
NI-BDCCT #SIZE	BIOCLEAN-D™, NON-STERILE, COVERALL WITH COLLAR & THUMB LOOPS, SMALL TO 4X-LARGE	30/CS
NI-BDCHT	BIOCLEAN-D™, NON-STERILE, COVERALL WITH INTEGRATED HOOD AND THUMB LOOPS	30/CS
NI-BDFC	BIOCLEAN-D™, NON-STERILE, COVERALL WITH INTEGRATED HOOD & BOOTS, ZIP FRONT W/FLAP COVER	30/CS
NI-BDSH	BIOCLEAN-D™, NON-STERILE, COVERALL WITH INTEGRATED HOOD	30/CS
NI-BDSC-L	SLEEVE COVERS	30/CS
NI-BDHD-L	DISPOSABLE HOOD	30/CS
NI-BDOB	DISPOSABLE OVERBOOT, SECURE TIES AND NON-SLIP SOLES	30/CS

PRODUCT #	DESCRIPTION	QTY
CN-SCR645 #SIZE	SHOE COVERS, BLUE, SIZE LARGE, X-LARGE, OR 2X-LARGE (50/PACK, 6 P/CS)	300/CS
ML-CRI2002	SHOE COVERS, W/NON-SKID BOTTOM, STANDARD, UP TO SIZE 12 (100/PACK)	300/CS
ML-CRI2003	SHOE COVERS, W/NON-SKID BOTTOM, X-LARGE, UP TO SIZE 15 (100/PACK)	200/CS



ACCURACY



EFFICIENCY



RELIABILITY



COST-EFFECTIVENESS



NAPRA COMPLIANT



SAFE FOR CHEMOTHERAPY





HAZARDOUS COMPOUNDING (PPE)



CHEMO GLOVES

Chemo Gloves have been specifically designed for pharmacy environments and tested per ASTM_D6978-05.

- Latex and powder free
- A selection of sterile and non-sterile chemo gloves
- Textured and allow easy double-donning

CHEMO GOWN

CritiGear Gowns: Tested against permeation standard ASTM D6978-05

BioClean-C Apron/Gowns: This garment closes in the back, but has an open back. It can be worn as an apron with sleeves over a coverall or as a gown.

- Available sterile and non-sterile



Products manufactured from low-linting fabrics and with clean packaging to eliminate the hazards of airborne contaminants



Meets the highest standards for personal protective equipment

CHEMO SHOE COVERS

Disposable, latex-free, non-skid, breathable, lightweight, durable, and impervious to liquids. Offer increased contamination control prevention in cleanrooms.

PRODUCT #	DESCRIPTION	QTY
CN-SCPL500	WHITE, SHOE COVERS, UNIVERSAL SIZE (100/PACK, 10 P/CS)	1000/CS



CritiGear™ Chemo Gown

YOU MAY ALSO LIKE
TOOLS AND CLEANING SOLUTIONS
MOPPING SYSTEM | PAGE 32





PRODUCT INDEX

PRODUCT #	DESCRIPTION	QTY
NI-BPZ #SIZE	P-ZERO™, STERILE, COLOUR NATURAL, POLYCHLOROPRENE, HAND SPECIFIC 6.0 TO 9.0	200PRS/CS
NI-BUPS #SIZE	ULTIMATE™, STERILE, COLOUR NATURAL, POLYCHLOROPRENE, HAND SPECIFIC 6.0 TO 9.0	200PRS/CS
NI-BENS #SIZE	EMERALD™, STERILE, GREEN, NITRILE, EASY DOUBLE-DONNING, HAND SPECIFIC 6.0 TO 10.0	200PRS/CS
NI-BNPS #SIZE	N-PLUS, STERILE, WHITE, NITRILE, ELBOW LENGTH PROTECTION, HAND SPECIFIC 6.0 TO 10.0	200PRS/CS
CN-HCGS00 #SIZE	CRITIGEAR™, STERILE, NITRILE GLOVES, X-SMALL TO 2X-LARGE	200PRS/CS
BI-CT371 #SIZE	CHEMOSAFETY™, NON-STERILE, NITRILE, 12" LENGTH, SMALL TO X-LARGE	200PRS/CS
BI-CT507 #SIZE	CHEMOBLOC™, NON-STERILE, NITRILE, 12" LENGTH CHEMO GLOVES AMBIDEXTROUS, SMALL TO X-LARGE	400EA/CS

PRODUCT #	DESCRIPTION	QTY
CN-HCGA0800-S/M*	CRITIGEAR™ GOWN, HAZ DRUG COMP W/THUMB LOOP, SMALL/MEDIUM	30/CS
CN-HCGA0800-L/XL*	CRITIGEAR™ GOWN, HAZ DRUG COMP W/THUMB LOOP, LARGE/X-LARGE	30/CS
CN-HCGA0800-2X/3XL*	CRITIGEAR™ GOWN, HAZ DRUG COMP W/THUMB LOOP, 2X-LARGE/3X-LARGE	30/CS
NI-S-BCAS-S	BIOCLEAN-C™, STERILE, PROTECTIVE APRON W SLEEVE (OPEN BACK), SMALL	40/CS
NI-S-BCAS-M	BIOCLEAN-C™, STERILE, PROTECTIVE APRON W SLEEVE (OPEN BACK), MEDIUM	40/CS
NI-S-BCAS-L	BIOCLEAN-C™, STERILE, PROTECTIVE APRON W SLEEVE (OPEN BACK), LARGE	40/CS
NI-S-BCAS-XL	BIOCLEAN-C™, STERILE, PROTECTIVE APRON W SLEEVE (OPEN BACK), X-LARGE	40/CS
NI-BCAS-S	BIOCLEAN-C™, NON-STERILE, PROTECTIVE APRON W SLEEVE (OPEN BACK), SMALL	40/CS
NI-BCAS-M	BIOCLEAN-C™, NON-STERILE, PROTECTIVE APRON W SLEEVE (OPEN BACK), MEDIUM	40/CS
NI-BCAS-L	BIOCLEAN-C™, NON-STERILE, PROTECTIVE APRON W SLEEVE (OPEN BACK), LARGE	40/CS
NI-BCAS-XL	BIOCLEAN-C™, NON-STERILE, PROTECTIVE APRON W SLEEVE (OPEN BACK), X-LARGE	40/CS
BI-CT5502	POLYCOATED IMPERVIOUS GOWN, MEDIUM	30/CS
BI-CT5503	POLYCOATED IMPERVIOUS GOWN, LARGE	30/CS
BI-CT5504	POLYCOATED IMPERVIOUS GOWN, X-LARGE	30/CS
BI-CT5505	POLYCOATED IMPERVIOUS GOWN, 2X-LARGE	30/CS
US-DP5003G	POLYCOATED IMPERVIOUS GOWN (OPEN BACK), MEDIUM	24/CS
US-DP5001G	POLYCOATED IMPERVIOUS GOWN (OPEN BACK), LARGE	24/CS
US-DP5002G	POLYCOATED IMPERVIOUS GOWN (OPEN BACK), X-LARGE	24/CS
US-DP5004G	POLYCOATED IMPERVIOUS GOWN (OPEN BACK), 2X-LARGE	24/CS
BI-CT5000	SEMI-PERMEABLE GOWN, MEDIUM	30/CS
BI-CT5100	SEMI-PERMEABLE GOWN, LARGE	30/CS
BI-CT5101	SEMI-PERMEABLE GOWN, X-LARGE	30/CS
BI-CT5102	SEMI-PERMEABLE GOWN, 2X-LARGE	30/CS
HC-CST210	POLYCOATED IMPERVIOUS GOWN, UNIVERSAL SIZE	25/CS
HC-CST210X	POLYCOATED IMPERVIOUS GOWN, X-LARGE	25/CS

* Additional sizes available (up to 7XL)



FACE/HEAD PROTECTION

EYEWEAR PROTECTION

Goggles are recommended when working at or above eye level and in various situations such as deactivating, decontaminating, cleaning, and when there is risk of splashes.



PRODUCT #	DESCRIPTION	QTY
US-DP5030G	CHEMOPLUS™, PROTECTIVE WRAP-AROUND GOGGLES, SPLASH RESISTANT, VENTILATED, UNIVERSAL FIT	6/CS
BI-CT0400	PROTECTIVE GOGGLES WITH SIDE SHIELD, PLASTIC, SPLASH RESISTANT, UNIVERSAL FIT	50/CS
NI-BCGS1	BIOCLEAR CLEARVIEW, STERILE, SINGLE-USE GOGGLES, INDIRECT VENTILATION SYSTEM	60/CS
NI-BVGS	BIOCLEAR CLEARVIEW, GAMMA-IRRADIATED, SINGLE-USE GOGGLES, INDIRECT VENTILATION SYSTEM	60/CS
NI-BCAG	BIOCLEAR CLEARVIEW, AUTOCLAVABLE PANORAMIC GOGGLES, LOWER INDIRECT VENTILATION	12/CS

HEAD AND BEARD COVERS

PRODUCT #	DESCRIPTION	QTY
ML-CRI1001	BLUE, 21" HAIR COVER (BOUFFANT CAPS) (100/PACK)	500/CS
ML-NONSH600	BLUE, SPUNBOND HEAD AND BEARD COVERS (100/PACK)	300/CS

MASKS PROTECTION

For most activities, an N95/N100 mask (NIOSH-approved) will protect against airborne particles.



ED-3MS8210

PRODUCT #	DESCRIPTION	QTY
ED-3MS8210	3M™ N95 PARTICULATE RESPIRATOR, MODEL 8210, CUSHIONING NOSE FOAM	20/CS
ED-3MS8210+	3M™ N95 PARTICULATE RESPIRATOR, MODEL 8210+, BRAIDED STRAPS	20/CS
ED-3M9210+	3M™ N95 PARTICULATE RESPIRATOR, MODEL 9210+, FLAT FOLD	20/CS
BI-CT0600	N95 RESPIRATOR MASK, DUST/MIST PARTICULATE, UNIVERSAL SIZE	120/CS
NI-MEA210-1	EARLOOP FACEMASK, CLIPS FOR FASTENING	600/CS
NI-MTA210-1	TIE-ON FACEMASK	500/CS
NI-BDBS-G	POUCH STYLE FACEMASK, NECK GUARD WITH HEADLOOP	200/CS
NI-BDBS	POUCH STYLE FACEMASK WITH HEADLOOP	100/CS
NI-VFM210-L	STERILE, CLEANROOM VISOR FACEMASK, SUPPLIED WITH PLASTIC CONNECTOR, CLIP, EAR LOOPS	100/CS
NI-VFM210-T	STERILE, CLEANROOM VISOR FACEMASK, SUPPLIED WITH PLASTIC CONNECTOR, CLIP, TIE-ON	100/CS
ML-NON27376	BLUE, SURGICAL MASK WITH TIES, UNIVERSAL SIZE (50/BOX)	300/CS



CHEMICAL CARTRIDGE RESPIRATORS AND ACCESSORIES

Vapors, gas, and particles protection

A chemical cartridge respirator with a pre-filter must be worn in the presence of vapours, gas, and particles (e.g., dust) or if there has been a spill.

We offer also various cartridges according to the chemical, decontamination after a spill, and the various cleaning agents that are used to clean, disinfect, or decontaminate the C-PEC.

- Three models available in small, medium, or large
- Full face/half face mask; lightweight, balanced design
- Visor, headgear, cleaning pads, and cartridges available



PRODUCT #	DESCRIPTION	QTY
ED-3MS6700	FULL FACEPIECE RESPIRATOR, REUSABLE, SMALL	EACH
ED-3MS6800	FULL FACEPIECE RESPIRATOR, REUSABLE, MEDIUM	EACH
ED-3MS6900	FULL FACEPIECE RESPIRATOR, REUSABLE, LARGE	EACH
ED-3MS6885	FULL FACE SHIELD COVER	25/CS
ED-6100	HALF MASK, 6000 SERIES, ECONOMICAL, SMALL	EACH
ED-6200	HALF MASK, 6000 SERIES, ECONOMICAL, MEDIUM	EACH
ED-6300	HALF MASK, 6000 SERIES, ECONOMICAL, LARGE	EACH
ED-3MS7501	HALF MASK, 7000 SERIES, EXTRA COMFORT, SMALL	EACH
ED-3MS7502	HALF MASK, 7000 SERIES, EXTRA COMFORT, MEDIUM	EACH
ED-3MS7503	HALF MASK, 7000 SERIES, EXTRA COMFORT, LARGE	EACH
ED-3MS82700	W96 VISOR, TO USE WITH ANY OF THE HALF MASKS	EACH
ED-3MS6878	SPECTACLE KIT, ALLOWS TO WEAR RX GLASSES WITH FULL FACE MASK	EACH
ED-3MS82501	H8A HEADGEAR	EACH
ED-3MS504	CLEANING PADS	100/CS
ED-3MS60921	CARTRIDGES (CHEMO REG. CLEANING), CERTAIN ORGANIC VAPOURS AND PARTICULATES	PAIR
ED-3MS60923	CARTRIDGES (CHEMO SPILL CLEANING) CERTAIN ORGANIC VAPOURS, CHLORINE, HYDROGEN CHLORIDE, AND SULFUR DIOXIDE OR HYDROGEN SULFIDE OR HYDROGEN FLUORIDE AND PARTICULATES	PAIR
ED-3MS60926	CARTRIDGES (COVERS A BROADER SPECTRUM OF CHEMICALS) CERTAIN ORGANIC VAPOURS, CHLORINE, HYDROGEN CHLORIDE, CHLORINE DIOXIDE, SULFUR DIOXIDE, HYDROGEN SULFIDE, AMMONIA/NETHYLAMIBE, FORMALDEHYDE, OR HYDROGEN FLUORIDE AND PARTICULATES	PAIR
ED-3MS6001	CARTRIDGES (REGULAR CLEANING - PERIDOX) CERTAIN ORGANIC VAPOURS	PAIR
ED-3MS6002	CARTRIDGES (REGULAR CLEANING - CHLORIDE) CHLORINE, HYDROGEN CHLORIDE, AND SULFUR DIOXIDE OR CHLORINE DIOXIDE OR HYDROGEN SULFIDE	PAIR



IV ADMIXTURE PREPARATION

IV DRUG TRANSFER SPIKES, PINS, AND ACCESSORIES

SYRINGE INFUSION



ESP60 SYRINGE PUMP™

The Syringe Pump Infusion is a proven, viable clinical alternative to minibag drug delivery. The ESP60 is designed to help you safely and cost-effectively transfer and deliver fluids.

- Durable, easy to use, automatic calibration, multiple speeds
- Alarms for occlusion, empty syringe, and low battery
- Unique encoder to guarantee $\pm 3\%$ accuracy
- Available in English or French

PROD. #	DESCRIPTION	QTY
EX-ESP	ESP60 SYRINGE PUMP	EACH
AC-EA-060-01	MICROBORE TUBING, 60" LENGTH WITH CLAMP, FEMALE AND MALE LUER CONNECTORS, APPROX. PRIMING VOLUME 0.3ML	50/CS
AC-EI-060-02	MICROBORE TUBING, 60" LENGTH WITH CLAMP, FEMALE AND MALE LUER CONNECTORS, APPROX. PRIMING VOLUME 0.6ML	50/CS

PREP MATS AND ABSORBENT PADS



Prep mats help stabilize the work surface for drug preparation and enhance workbench safety for technicians, nurses, and pharmacists when handling or administering chemotherapy drugs.

- Choice of premium (3 layers), standard (2 layers), or economy (1 layer)
- Sterile or non-sterile pads
- Added layers to retain and trap drug residue



CN-HCPD0001

PRODUCT #	DESCRIPTION	QTY
NI-S-BCPM-4025B	CHEMO PREP MAT, STERILE, 3-LAYER, 16" X 10"	200/CS
NI-S-BCPM-5640B	CHEMO PREP MAT, STERILE, 3-LAYER, 22" X 16"	100/CS
CN-HCPD0005	CONTEC PREP PAD, IRRADIATED, 16" X 21"	600/CS
CN-HCPD0005-BB	CONTEC PREP PAD, IRRADIATED, 16" X 21"	150/CS
CN-HCPD0001	CONTEC PREP PAD, NON-STERILE, 16" X 21"	600/CS
CN-HCPD0001-BB	CONTEC PREP PAD, NON-STERILE, 16" X 21"	150/CS
BI-CT0300	SMALL PREMIUM MAT, NON-STERILE, 3 LAYERS, 11" X 17"	50/CS
BI-CT0302	LARGE PREMIUM MAT, NON-STERILE, 3 LAYERS, 16" X 22"	50/CS
BI-CT0303	X-LARGE PREMIUM MAT, NON-STERILE, 3 LAYERS, 17" X 69"	75/CS
US-DP5010M	MEDIUM ECONOMY MAT, NON-STERILE, 1 LAYER, 17" X 18"	125/CS
BI-BS0013	ABSORBENT PAD WITH SOLIDIFYING AGENT, 12" X 12"	100/CS

SYRINGE TIP CAPS



SYRINGE TIP CAP AND LUER LOCK CAP

Syringe tip cap tray. Tamper-evident breakaway sleeves. Luer lock for IV or chemo prep and batching. Available in different colours and formats.



6.6.5.2 Aspects of compounding hazardous preparations

PRODUCT #	DESCRIPTION	QTY	PICTURE
MD-TEC10 #COLOUR	PREP-LOCK™ TAMPER-EVIDENT SYRINGE TIP CAP TRAY, LUER LOCK, RED, BLUE, WHITE, OR BLACK (10/TRAY, 10T/CS)	100/CS	1
II-57100 #COLOUR	STERILE, LUER LOCK CAP, RED, BLUE, GREEN, VIOLET, WHITE, OR YELLOW (10/TRAY, 10T/CS)	100/CS	2 & 4
SH-682119	SYRINGE TIP CAP TRAY (25/TRAY, 40T/CS)	1000/CS	3
SH-682101	SYRINGE TIP CAP TRAY (10/TRAY, 100T/CS)	1000/CS	3
CL-IV2100	COMBI-CAP™, RED M/F LUER LOCK CAP, INDIVIDUALLY PACKAGED	100/CS	5

INJECTION SITE VALVE



Attach needle size of choice to the valve luer connection and insert into the injection port of IV bag. Attach syringe to add or withdraw diluent or medication to or from IV bag.

PRODUCT #	DESCRIPTION	QTY
MR-6039BV	BIDIRECTIONAL VALVE WITH MALE/FEMALE CONNECTORS	50/CS

NEEDLELESS VIAL ACCESS AND ADAPTOR



AC-19C

Vented plastic cannulas for reconstituting drug vials. Low cost, blunt fill access cannula or unique lateral flow design that directs diluent against side walls to minimize foaming.

PRODUCT #	DESCRIPTION	QTY
SH-540111	NEEDLELESS VIAL ACCESS CANNULA, 16G (100/PACK, 10P/CS)	1000/CS
AC-19C01	FLOW-EZE VENT NEEDLE	100/CS
AC-19C	FLOW-EZE VENT NEEDLE	500/CS



Access device with needle-free SmartSite™ valve for multiple withdraws or additions of fluid to and from vials. Easy-to-use and secure connection.

PRODUCT #	DESCRIPTION	QTY
AC-SM-007	VIAL ACCESS DEVICE WITH NEEDLE-FREE SMARTSITE™ VALVE	50/CS



IV ADMIXTURE PREPARATION

IV DRUG TRANSFER SPIKES, PINS, AND ACCESSORIES

IV DRUG TRANSFER SPIKES AND PINS

CHEMOPROTECT®



6.6.5.2 Aspects of compounding hazardous preparations



PROD. #	DESCRIPTION	QTY
CO-TS350	CHEMOPROTECT® IV/CHEMO TRANSFER SPIKE WITH 0.2µ HYDROPHOBIC FILTER	50/CS
CO-C350MP	CHEMOPROTECT®, STERILE (5/PACK, 50 P/CS)	250/CS
CO-TS350N	CHEMOPROTECT® AND SWAN LOCK SWABBABLE VALVE CONNECTOR FOR CLOSED ACCESS	50/CS

CHEMOBLOC® VIAL VENTING SYSTEM



6.6.5.2 Aspects of compounding hazardous preparations



PROD. #	DESCRIPTION	QTY
US-DP5201V	CHEMOBLOC® VIAL VENTING SYSTEM WITH 0.2µ HYDROPHOBIC FILTER (SMALL VIALS)	50/CS

CHEMO-VENT®



6.6.5.2 Aspects of compounding hazardous preparations



PROD. #	DESCRIPTION	QTY
II-31-50	CHEMO-VENT® 20 GAUGE X 1.5 INCH, STAINLESS STEEL NON-CORING VENTING NEEDLE WITH 0.2µ HYDROPHOBIC FILTER (FOR VENTING ONLY APPLICATION)	100/CS

SUREGRIP™



Chemo Spike

6.6.5.2 Aspects of compounding hazardous preparations



PROD. #	DESCRIPTION	QTY
AC-19CHTP	SUREGRIP™ CHEMO TRANSFER SPIKE WITH 0.2µ HYDROPHOBIC FILTER (LARGE VIALS)	100/CS

Transfer Pins

PROD. #	DESCRIPTION	QTY
AC-19TP	SUREGRIP™ TRANSFER PIN, LARGE BORE	100/CS
AC-19MTP	SUREGRIP™ TRANSFER PIN, SMALL BORE FOR DRUG VIAL RECONSTITUTION	100/CS
AC-19MMTP	SUREGRIP™ TRANSFER PIN, MINI BORE FOR DRUG VIAL RECONSTITUTION	100/CS

TAKY-SPIKE PLUS



PRODUCT #	DESCRIPTION	QTY
CL-90130000-50	TAKY-SPIKE PLUS, GREEN, IV TRANSFER PIN	50/CS
CL-90130000	TAKY-SPIKE PLUS, GREEN, IV TRANSFER PIN, LARGER BOX	200/CS

PHARMACY TRANSFER SETS



PHARMADD TRANSFER SET

Dispensing spike extension set with vent/no vent option, high flow stopcock, slide clamp, and luer lock connector

PRODUCT #	DESCRIPTION	QTY
MR-3004	PHARMADD TRANSFER SET	50/CS



MULTIPLE ADDITIVE SET

Dispensing spike extension set with valve mechanism, slide clamp, and luer lock connector

PRODUCT #	DESCRIPTION	QTY
MR-3002	MULTIPLE ADDITIVE SET	50/CS



SPIKE/SPIKE TRANSFER SET

2" transfer set with high flow tubing, two non-vented small spikes and clamp

PRODUCT #	DESCRIPTION	QTY
MR-3046	SPIKE/SPIKE TRANSFER SET	100/CS

DISPOSABLE AMPOULE BREAKERS

SAFEBREAK™

- Plastic fracture and safe collar for breaking pre-scored glass
- Designed to protect personnel against glass splinters and prevent cross-contamination

PRODUCT #	DESCRIPTION	QTY
MD-SB140	SAFEBREAK™, 1ML TO 4ML	100/CS
MD-SB510	SAFEBREAK™, 5ML TO 10ML	100/CS
MD-SB1120	SAFEBREAK™, 11ML TO 20ML	100/CS



YOU MAY ALSO LIKE

COMPOUNDING PERSONAL PROTECTION EQUIPMENT (PPE)
HAZARDOUS COMPOUNDING (PPE) | PAGE 10



IV ADMIXTURE PREPARATION

IV DRUG TRANSFER SPIKES, PINS, AND ACCESSORIES

FILTRATION

FILTER ASPIRATOR

Filter aspirator for filtration from ampoules



PRODUCT #	DESCRIPTION	QTY	PICTURE
MD-IV1530	FILTER ASPIRATOR 18 GAUGE X 3" BLUNT NEEDLE, 5μ FILTER, CONSTRUCTED STAINLESS STEEL, CUP SHAPED, NON-SHEDDING, MICROPOUROUS SINTERED DEPTH FILTER.	100/CS	1
AC-FS175B	FILTER STRAW (FLEXIBLE PLASTIC 1.75" LENGTH) 5M FOR NEEDLE-FREE ASPIRATION OF PARTICULATES	100/CS	

FILTER NEEDLES



Filter needle applications for access through injection port on IV bags

PRODUCT #	DESCRIPTION	QTY
MD-IV1518	FILTER NEEDLE 18 GAUGE X 1.5", 5μ FILTER	100/CS
MD-IV1520	FILTER NEEDLE 20 GAUGE X 1.5", 5μ FILTER	100/CS



PHARMASSURE® SYRINGE FILTERS

Individually sterile packaged range of hydrophilic disk filters for trapping bacteria and particulates. PharmAssure® brand of Pall Corporation, a world leader in pharmaceutical-filtration devices.

PRODUCT #	DESCRIPTION	QTY	PICTURE
MD-HP1002	0.22μ, 0.98", FEMALE LUER LOCK INLET, MALE LUER LOCK OUTLET, HYDROPHILIC, BI-DIRECTIONAL	50/CS	
MD-HP1004	0.45μ, SUPOR® MEMBRANE, 0.98", CLEAR/RED	50/CS	
MD-HP1012	1.2μ, SUPOR® MEMBRANE, 0.98", CLEAR/BLUE, 3" 1 TPN	50/CS	1
MD-HP1050	5μ, SUPOR® MEMBRANE, 0.98", GREEN/GREEN, HIGH FLOW	50/CS	2

PHARMASSURE® VENT FILTERS



Hydrophobic disk filters (0.2μ) for venting

PROD. #	DESCRIPTION	QTY
MD-HP2002	0.2μ FILTER, 0.98" VENT FILTERS, CLEAR, FOR STERILIZATION, BACTERIA RETENTION & VENTING	50/CS



FILTERS

High pressure, high flow filtration especially for use with Pharmassist™ automated dispensing pump batching applications.

PRODUCT #	DESCRIPTION	QTY	PICTURE
AC-EB-060-26	60" EXTENSION SET WITH 1.2μ FILTER	50/CS	
AC-FL1000FM	LARGE SURFACE AREA 0.2μ BACTERIAL RETENTIVE FILTER, FEMALE/MALE LUER LOCK CONNECTORS	100/CS	2
AC-FL1002FM	LARGE SURFACE AREA 5μ PARTICULATE FILTER, FEMALE/MALE LUER LOCK CONNECTORS, HIGH PRESSURE RATING FOR IV ADMIXTURE PREPARATION PUMP BATCHING PROCEDURES	100/CS	1

SYRINGE TIP ADAPTORS



1

2

Syringe tip adaptors for batching and syringe-to-syringe transfer connectors

- EX-SA250: Recessed slip in the connection point allows users to change syringes quickly. Capped luer connection point reduces touch contamination and provides secure fit.
- II-57-13: Syringe connector (luer/luer) for syringe-to-syringe transfers requiring secure connection both sides (i.e., transferring chemo drugs)

PRODUCT #	DESCRIPTION	QTY	PICTURE
EX-SA250	SYRINGE CONNECTOR, SLIP/FEMALE LUER	250/CS	1
II-57-13	SYRINGE CONNECTOR, FEMALE LUER/ FEMALE LUER	100/CS	2

TRANSFER VALVE SETS

Transfer valve sets allow for withdrawal of various volumes of diluent or injectable medications into syringes.

Available with two-way valve mechanism to allow for syringe volume adjustment or one-way valve to eliminate potential for medication or diluent to re-enter the IV bag.



MR-3005

PRODUCT #	DESCRIPTION	QTY
AC-19TPV	TRANSFER SPIKE, VENTED, TWO-WAY CHECK VALVE	100/CS
AC-SM-013	LARGE NON-VENTED SPIKE W/ SMARTSITE® NEEDLELESS VALVE	50/CS
IU-CH10	CLAVE® SWABBABLE CONNECTOR, ACCESS DEVICE IV BAG, TWO-WAY CHECK VALVE	50/CS
MR-3005	TRANSFER SPIKE, VENTED, ONE-WAY CHECK VALVE AND SWABBABLE LUER ACCESS VALVE	100/CS
MR-3006	TRANSFER SPIKE, NON-VENTED, TWO-WAY CHECK VALVE	100/CS

MULTI-DOSE IV BAG RINGS



Durable, resilient, round plastic rings for keeping multiple minibags together during transport from pharmacy to nursing units in a CIVA program. Choice of colours allows for colour-coding system options.

- 10 colours available: black, blue, brown, green, orange, pink, purple, red, white, and yellow

PRODUCT #	DESCRIPTION	QTY
MD-PC2116	IV BAG RING	500/CS



IV ADMIXTURE PREPARATION

IV DRUG TRANSFER SPIKES, PINS, AND ACCESSORIES

PHARMACY SYRINGE TRAYS

Sterile, empty syringes (monoject brand) in plastic trays with Tyvek® lid for batching of IV syringes. Syringes ready to use-no tip cap or packaging to remove.

6.6.5.2 Aspects of compounding hazardous preparations



PRODUCT #	DESCRIPTION	QTY
SH-501459	1ML PHARMACY SYRINGE TRAY (25/TRAY, 40T/CS)	1000/CS
SH-513207	3ML PHARMACY SYRINGE TRAY, LUER LOCK (25/TRAY, 8T/CS)	200/CS
SH-516200	6ML PHARMACY SYRINGE TRAY, LUER LOCK (25/TRAY, 8T/CS)	200/CS
SH-512258	12ML PHARMACY SYRINGE TRAY, LUER LOCK (25/TRAY, 8T/CS)	200/CS
SH-520251	20ML PHARMACY SYRINGE TRAY, LUER LOCK (25/TRAY, 8T/CS)	200/CS
SH-535101	35ML PHARMACY SYRINGE TRAY, LUER LOCK (10/TRAY, 12T/CS)	120/CS
SH-560232	60ML PHARMACY SYRINGE TRAY, LUER LOCK (10/TRAY, 12T/CS)	120/CS

EMPTY STERILE GLASS VIALS

Empty sterile glass vials in compact, durable trays.
De-pyrogenated dry heat sterilization process.

PRODUCT #	DESCRIPTION	QTY
AL-ESV01	1ML EMPTY STERILE GLASS VIAL	1000/CS
AL-ESV02	2ML EMPTY STERILE GLASS VIAL	100/CS
AL-ESV02A	2ML EMPTY STERILE GLASS VIAL, AMBER	100/CS
AL-ESV05	5ML EMPTY STERILE GLASS VIAL	25/CS
AL-ESV05A	5ML EMPTY STERILE GLASS VIAL, AMBER	25/CS
AL-ESV010	10ML EMPTY STERILE GLASS VIAL	25/CS
AL-ESV010A	10ML EMPTY STERILE GLASS VIAL, AMBER	25/CS
AL-ESV030	30ML EMPTY STERILE GLASS VIAL	25/CS
AL-ESV030A	30ML EMPTY STERILE GLASS VIAL, AMBER	25/CS
AL-ESV050	50ML EMPTY STERILE GLASS VIAL	25/CS
AL-ESV050A	50ML EMPTY STERILE GLASS VIAL, AMBER	25/CS
AL-ESV100	100ML EMPTY STERILE GLASS VIAL	25/CS
AL-ESV100A	100ML EMPTY STERILE GLASS VIAL, AMBER	25/CS



TRANSPORT, STORAGE AND DISPOSAL DEVICES



Bags and containers for safe handling and disposal of hazardous drugs

6.6.5.2 Aspects of compounding hazardous preparations



PRODUCT #	DESCRIPTION	QTY
RD-Q134	CLEAR, 4ML PRE-LABELLED TRANSPORT BAG, 6" X 9"	1000/CS
RD-Q455	CLEAR, 4ML PRE-LABELLED TRANSPORT BAG, 9" X 12"	500/CS
RD-Q135	CLEAR, 4ML PRE-LABELLED TRANSPORT BAG, 12" X 15"	500/CS
RD-CST610	WHITE, 113L PRE-LABELLED CHEMO WASTE BAG	50/CS
BI-8982CRH	RED, 7.6L CHEMO CONTAINER HINGE LID	20/CS
BI-CT1500	CHEMO WASTE CONTAINER SOFT CORRUGATED, 76L, 4ML	6/CS
BI-CT2100	CHEMO WASTE CONTAINER BAG FOR CORRUGATED, 76L, 4ML	100/CS

BAGS AND FILL SETS

SECURE™ GRAVITY FILL SETS

PROD. #	DESCRIPTION	QTY
SE-58794	SECURE™ 1 LEG GRAVITY FILL SET	50/CS
SE-58782	SECURE™ 2 LEG GRAVITY FILL SET	50/CS
SE-58783	SECURE™ 3 LEG GRAVITY FILL SET	50/CS

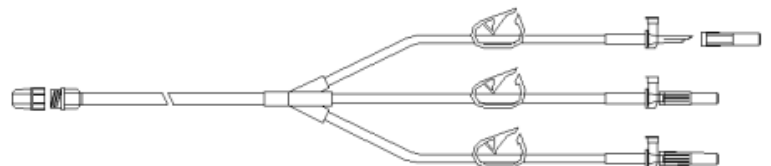

SECURE™ LUER FILL SET

PROD. #	DESCRIPTION	QTY
SE-58784	SECURE™ 1 LEG LUER ADAPTOR, FEMALE	50/CS

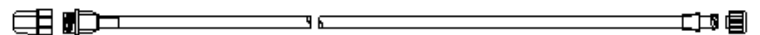

YOU MAY ALSO LIKE
LIQUID PACKAGING SOLUTIONS
SMARTPHARMA | PAGE 49



IV ADMIXTURE PREPARATION

IV DRUG TRANSFER SPIKES, PINS, AND ACCESSORIES

BAGS AND FILL SETS

SECURE™ EVA 2-PORT BAGS

PRODUCT #	DESCRIPTION	QTY
SE-66042	SECURE™ 50ML (EVA) 2-PORT EMPTY BAG, STERILE	50/CS
SE-66040	SECURE™ 100ML (EVA) 2-PORT EMPTY BAG, STERILE	50/CS
SE-66045	SECURE™ 250ML (EVA) 2-PORT EMPTY BAG, STERILE	50/CS
SE-66050	SECURE™ 500ML (EVA) 2-PORT EMPTY BAG, STERILE	50/CS
SE-66055	SECURE™ 1000ML (EVA) 2-PORT EMPTY BAG, STERILE	50/CS

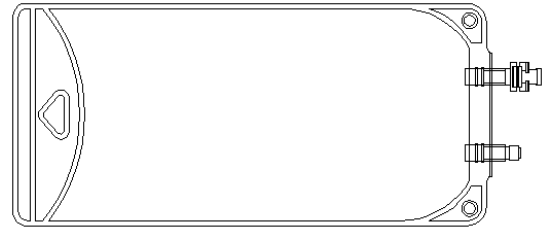

SECURE™ EVA LEGLESS BAGS

PRODUCT #	DESCRIPTION	QTY
SE-66410	SECURE™ 500ML EMPTY MIXING BAG, STERILE	50/CS
SE-66415	SECURE™ 1000ML EMPTY MIXING BAG, STERILE	50/CS
SE-66425	SECURE™ 2000ML EMPTY MIXING BAG, STERILE	50/CS
SE-66430	SECURE™ 3000ML EMPTY BAG, STERILE	50/CS

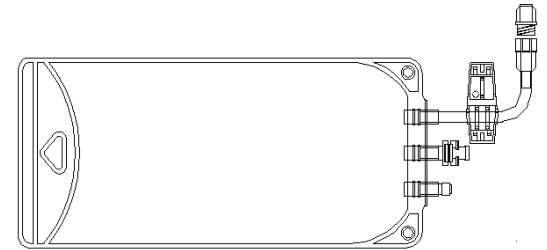

SECURE™ EVA GRAVITY BAGS

PROD. #	DESCRIPTION	QTY
SE-66100	SECURE™ 1000ML EVA GRAVITY BAG, 2 LEG DETACHABLE	50/CS
SE-66105	SECURE™ 2000ML EVA GRAVITY BAG, 2 LEG DETACHABLE	50/CS
SE-66110	SECURE™ 3000ML EVA GRAVITY BAG, 2 LEG DETACHABLE	50/CS
SE-66120	SECURE™ 1000ML EVA GRAVITY BAG, 3 LEG DETACHABLE	50/CS
SE-66125	SECURE™ 2000ML EVA GRAVITY BAG, 3 LEG DETACHABLE	50/CS
SE-66130	SECURE™ 3000ML EVA GRAVITY BAG, 3 LEG DETACHABLE	50/CS
SE-66135	SECURE™ 4000ML EVA GRAVITY BAG, 3 LEG DETACHABLE	50/CS

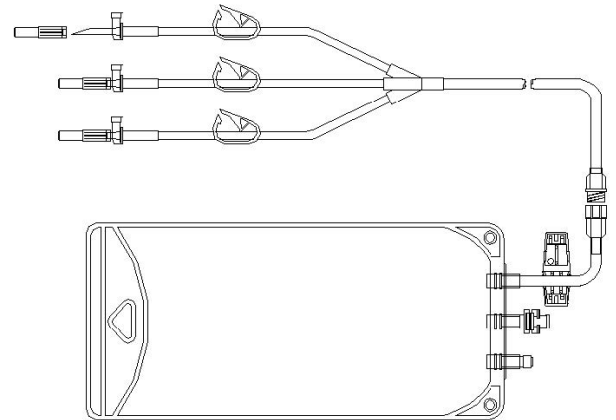

SECURE™ EVA LEGLESS BAGS (FEMALE CONNECTOR)

PROD. #	DESCRIPTION	QTY
SE-66615	SECURE™ 1500ML EVA DUAL CHAMBER TPN CONTAINER, LEGLESS	42/CS
SE-66630	SECURE™ 3000ML EVA DUAL CHAMBER TPN CONTAINER, LEGLESS	42/CS
SE-66640	SECURE™ 4000ML EVA DUAL CHAMBER TPN CONTAINER, LEGLESS	42/CS

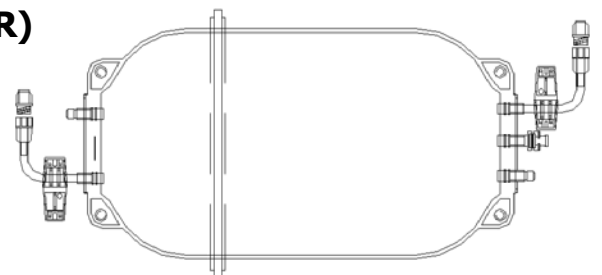

SECURE™ EVA LEGLESS BAGS (FEMALE CONNECTOR)

PROD. #	DESCRIPTION	QTY
SE-66205	SECURE™ 250ML EVA LEGLESS BAG, FEMALE SCREW CONNECTOR	50/CS
SE-66210	SECURE™ 500ML EVA LEGLESS BAG, FEMALE SCREW CONNECTOR	50/CS
SE-66215	SECURE™ 1000ML EVA LEGLESS BAG, FEMALE SCREW CONNECTOR	50/CS
SE-66225	SECURE™ 2000ML EVA LEGLESS BAG, FEMALE SCREW CONNECTOR	50/CS
SE-66230	SECURE™ 3000ML EVA LEGLESS BAG, FEMALE SCREW CONNECTOR	50/CS
SE-66235	SECURE™ 4000ML EVA LEGLESS BAG, FEMALE SCREW CONNECTOR	50/CS

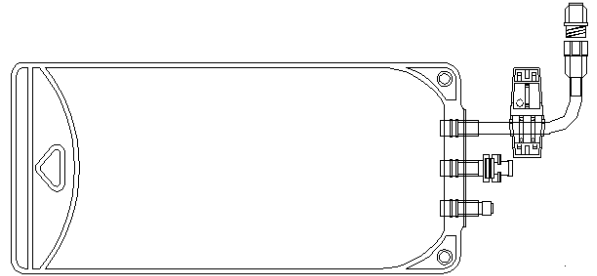

SECURE™ EVA LEGLESS BAGS (MALE CONNECTOR)

PROD. #	DESCRIPTION	QTY
SE-66405	SECURE™ 250ML EVA LEGLESS BAG, MALE SCREW CONNECTOR	50/CS
SE-66410	SECURE™ 500ML EVA LEGLESS BAG, MALE SCREW CONNECTOR	50/CS
SE-66415	SECURE™ 1000ML EVA LEGLESS BAG, MALE SCREW CONNECTOR	50/CS
SE-66425	SECURE™ 2000ML EVA LEGLESS BAG, MALE SCREW CONNECTOR	50/CS
SE-66430	SECURE™ 3000ML EVA LEGLESS BAG, MALE SCREW CONNECTOR	50/CS
SE-66435	SECURE™ 4000ML EVA LEGLESS BAG, MALE SCREW CONNECTOR	50/CS

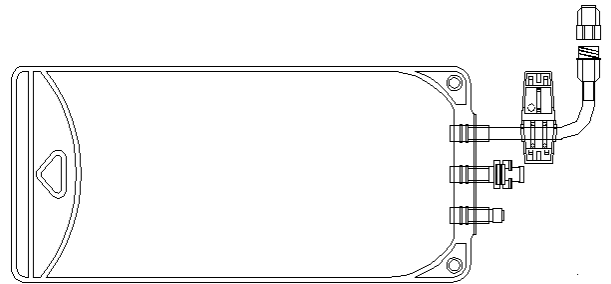

SECURE™ PVC 2-PORT BAGS

PROD. #	DESCRIPTION	QTY
SE-58719	SECURE™ 100ML EMPTY MIXING BAG, STERILE	200/CS

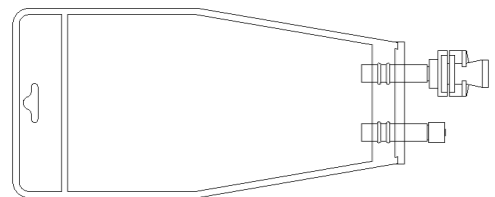

SECURE™ COMPOUNDING ACCESSORIES

PROD. #	DESCRIPTION	QTY
SE-58948	SECURE™ METAL SEALING CLIPS	50/CS
SE-58997	SECURE™ NON-REOPENING CLAMP	50/CS
SE-58996	SECURE™ REUSABLE PINCH CLAMP	50/CS
SE-58949	SECURE™ REUSABLE SLIDE CLAMP	50/CS

COVER AND ZIPLOC BAGS

Available in various sizes and formats

- Amber cover bags
- Clear ziplock bags
- Amber ziplock bags



IV ADMIXTURE PREPARATION

IV DRUG TRANSFER SPIKES, PINS, AND ACCESSORIES

SEALS, LABELS AND TAMPER-EVIDENT ACCESSORIES

TAMPER-EVIDENT SYRINGE BAGS

Aggressive tamper-evident closure and 3 mil polyethylene thickness provides protection while the double-perforation design allows for easy tearaway access to the syringe. Two sizes to accommodate all syringe sizes.

 6.9 Transport and delivery of compounded sterile preparations

PRODUCT #	DESCRIPTION	QTY
MD-TE-280	CLEAR, TAMPER-EVIDENT SYRINGE BAG, WRITE-ON, 2" X 8"	1000/CS
MD-TE-312	CLEAR, TAMPER-EVIDENT SYRINGE BAG, WRITE-ON, 3" X 12"	1000/CS



STERI-TAMP®

Steri-Tamp® has a patented dual layer that leaves with an "opened" marking. Available in various sizes and colours.



 6.9 Transport and delivery of compounded sterile preparations

PRODUCT #	DESCRIPTION	QTY
ST-ST5112	BLUE, IV BAG PORT SEALS	1000/ROLL
ST-ST5103	RED, IV BAG PORT SEALS	1000/ROLL
ST-ST1102	BLUE, VIAL SEALS, 1.10"	1000/ROLL
ST-ST900901	SILVER, VIAL SEALS, 0.78"	1000/ROLL
ST-ST2103	RED, VIAL SEALS, 0.51"	1000/ROLL
ST-ST4103	RED, SYRINGE SEAL	1000/ROLL
ST-ST4112	TAMPER-CLEAR SYRINGE SEAL™	1000/ROLL
ST-ST6101	BELLY BUTTON BAG PORT SEALS (HOSPIRA) AND ECOFLAC® CONTAINER (GREEN)	1000/ROLL
ST-ST7103	YELLOW, IV BAG PORT SEALS, CHEMO	1000/ROLL

TAMPALERTAPE™

Distinct "VOID OPENED" signature is invisible until opened. Ideal for medication protection, lab samples, drug testing, confidential records, and documents.

PRODUCT #	DESCRIPTION	QTY
MD-VD12-5	TAMPALERTAPE 0.5" X 500"	EACH





SECURSEAL®

Economical, zero-paper, zero-shedding material. Several sizes, models and colours. Dispenser rack available.



 6.9 Transport and delivery of compounded sterile preparations

PRODUCT #	DESCRIPTION	QTY	PICTURE
WI-10-#COLOUR	SECURSEAL®, SERIES 10, BAG SEAL, BAXTER IV BAG	1000/ROLL	4
WI-30-#COLOUR	SECURSEAL®, SERIES 30, BAG SEAL, LARGE	1000/ROLL	5
WI-28-#COLOUR	SECURSEAL®, SERIES 28, BOTTLE TOPS, 0.78"	1000/ROLL	1
WI-55-#COLOUR	SECURSEAL®, SERIES 55, PORT BAG SEAL, HOSPIRA IV BAG	1000/ROLL	2
WI-20-#COLOUR	SECURSEAL®, SERIES 20, VIALS, 0.78"	1000/ROLL	1
WI-13-#COLOUR	SECURSEAL®, SERIES 13, VIALS, 0.51"	1100/ROLL	N/A
WI-80-800	SECURSEAL®, SERIES 80, SYRINGE/CONTAINER SEALS	1100/ROLL	3
WI-R-200	SEAL DISPENSER RACK	EACH	N/A



CYTOTOXIC AND CHEMO LABELS

Approved cytotoxic and chemo symbol. Reduces risk of errors, assures clinician and patient safety.



 6.6.5.2 Aspects of compounding hazardous preparations

PRODUCT #	DESCRIPTION	QTY
MR-CL1.5x1	CYTOTOXIC LABEL, 1.5" X 1"	2000/ROLL
MR-CL2x2	CYTOTOXIC LABEL, 2" X 2"	2000/ROLL
MR-CL4x4	CYTOTOXIC LABEL, 4" X 4"	1000/ROLL
BI-CT6006	CHEMO RISKGARD™, CAUTION LABEL, 0.5" X 3" (500/ROLL, 4R/CS)	2000/CS
BI-CT6011	CHEMO RISKGARD™, CAUTION LABEL, 1" X 3" (500/ROLL, 4R/CS)	2000/CS
BI-CT6016	CHEMO RISKGARD™, CAUTION LABEL, 1.5" X 3" (500/ROLL, 4R/CS)	2000/CS



YOU MAY ALSO LIKE

COMPOUNDING, LABELLING AND PACKAGING SOLUTIONS
PALP, ANCILLARY MEDICATION LABELLING | PAGE 53



IV ADMIXTURE PREPARATION

IV DRUG TRANSFER SPIKES, PINS, AND ACCESSORIES

SEALS, LABELS AND TAMPER-EVIDENT ACCESSORIES

HIGH ALERT, LINE-TRACING LABELS

Three-part labels for flagging medications on the IV bag and at the top and bottom of the IV administration set at patient bedside

PRODUCT #	DESCRIPTION	QTY
MD-TL-HA101	EPIDURAL HIGH ALERT LABEL	1000/CS
MD-TL-HA102	CHEMO HIGH ALERT LABEL	1000/CS
MD-TL-HA103	HEPARIN HIGH ALERT LABEL	1000/CS
MD-TL-HA104	INSULIN HIGH ALERT LABEL	1000/CS
MD-TL-HA105	OXYTOCIN HIGH ALERT LABEL	1000/CS
MD-TL-HA106	MAGNESIUM SULFATE HIGH ALERT LABEL	1000/CS
MD-TL-HA107	NARCOTIC HIGH ALERT LABEL	1000/CS
MD-TL-HA108	PARALYTIC HIGH ALERT LABEL	1000/CS
MD-TL-HA109	IV NUTRITION HIGH ALERT LABEL	1000/CS
MD-TL-HA110	"BLANK" HIGH ALERT LABEL	1000/CS
MD-TL-HA111	"BLANK" HIGH ALERT LABEL RED	1000/CS

SHRINKSAFE® BANDS

Safety Control Seals

Easy-to-apply shrink band system for High Alert medications

PRODUCT #	DESCRIPTION	QTY
MD-SS100	ORANGE, PARALYTIC HIGH ALERT BANDS	250/CS
MD-SS101	GREEN, CONCENTRATED HIGH ALERT BANDS	250/CS
MD-SS200	CLEAR, FULL VISIBILITY BANDS, LARGE	250/CS
MD-SS201	CLEAR, FULL VISIBILITY BANDS, SMALL	250/CS
MD-SS800	HEAT DEVICE	EACH
MD-SS700	HEAT RESISTANT TRAYS	EACH



SAFETY CONTROL SEALS

Emergency Drug Box

To close, insert tail through opening and pull tight. To open, twist to break. For emergency drug boxes and other tamper-evident requirements.

PROD. #	DESCRIPTION	QTY
MD-PC155	PULL THRU SEALS	100/CS
MD-PC152R	PULL THRU SEALS, EXTRA LONG	100/CS
MD-PC154	FAST SEAL PADLOCK DESIGN	100/CS
MD-7050	FAST SEAL FORK DESIGN	100/CS



CLEANROOM CONTAMINATION CONTROL ACCESSORIES



CLEANROOM SPILL KITS Pharmacy/Nursing Admin/Home Health

Spill kits with various contents designed for safe and fast cleanup of chemotherapy drug spills. More information on spill kit content on our website.



6.11.2 Spills

PROD. #	DESCRIPTION	QTY
HC-CST700	ASSURANCE 4 SAFETY SPILL KIT, PACKAGED IN A CONVENIENT PLASTIC BUCKET TO EASE DISPOSAL	4/CS

CLEANSTEP™ Cleanroom Adhesive Mats

CleanStep™ is a contamination control mat designed to capture particulates prior to entry into controlled areas

PRODUCT #	DESCRIPTION	QTY
TX-AMA183682B*	BLUE BASE, CLEAR FILM, 60 LAYERS/MAT, 18" X 36"	4/CS

* More options available

NON-HAZARDOUS DISPOSAL SOLUTIONS

RX DESTROYER™ Medication deactivation

Easy-to-use solution begins dissolving and adsorbing medications on contact. Patented solution renders drugs irretrievable minimizing diversion and abuse. Effective for 1000s of non-hazardous medications.

PROD. #	DESCRIPTION	QTY
GB-RX30	RX DESTROYER™ ALL-PURPOSE, 113.5L DRUM	EACH
GB-RX5	RX DESTROYER™ ALL-PURPOSE, 19L CONTAINER	EACH
GB-RX2.5	RX DESTROYER™ ALL-PURPOSE, 9.5L BOTTLES	2/CS
GB-1.0PRO	RX DESTROYER™ ALL-PURPOSE, 3.8L BOTTLES	4/CS
GB-RX64	RX DESTROYER™ ALL-PURPOSE, 1.8L BOTTLES	4/CS
GB-RX16	RX DESTROYER™ ALL-PURPOSE, 0.45L BOTTLES	12/CS

* Other sizes available





QUALITY AND CONTAMINATION CONTROL TOOLS AND CLEANING SOLUTIONS



WIPES AND ACCESSORIES

PRE-WETTED WIPERS

Multiple choices of presaturated wipers with sterile 70% IPA

- ISO Class 5 compatible, low particle counts and extractables
- Choice of polyester/cellulose or polyester
- Resealable pouches preserve saturation level and cleanliness



-  6.6.3 Introducing products and equipment into the cleanroom
-  6.6.4 Cleaning and disinfecting the primary engineering control
-  6.6.5 Aseptic technique for compounding sterile preparations

PROD. #	DESCRIPTION	QTY
CN-PSC20005	PROSAT™ STERILE PRESATURATED, CELLULOSE/POLYESTER WIPERS, 9" X 11" (50/PACK, 28P/CS)	1400/CS
CN-PS-911EB	PROSAT™ STERILE PRESATURATED, POLYPROPYLENE WIPERS, 9" X 11" (30/PACK, 48P/CS)	1440/CS
CN-HCPS0044	PROSAT™ CRITICAL SITE™ STERILE PRESATURATED, 100% POLYESTER, 4" X 4" (100/PACK, 6P/CS)	600/CS
TX-3285	STERILE PRE-WETTED WIPES W/ 70% IPA 9" X 9"	400/CS

CLEAN SCRUB SPONGE



The Clean Scrub™ Sponge is ideal for sink and drain scrubbing, yet will not scratch most surfaces and is compatible with a wide range of solutions.

PROD. #	DESCRIPTION	QTY
CN-VKSC0004	CLEAN SCRUB SPONGE, 5" (W) X 3" (D) X 0.6" (H) (6/PACK, 8P/CS)	48/CS

SANOTEX® Environmental Surface Wipes



Sanotex® is an enclosed dispenser that preserves wipe and chemical potency. It is an economical alternative to spray bottle or cloth and open bucket cleaning and disinfecting systems.

PRODUCT #	DESCRIPTION	QTY
CN-85340	SANOTEX® WIPES, 10" X 12" (60/PACK, 6P/CS)	360/CS
CN-85339	SANOTEX® WIPES, 6" X 8" (150/PACK, 6P/CS)	900/CS
CN-85338	SANOTEX® WIPES, 10" X 12" (40/PACK, 8P/CS)	320/CS
CN-85337	SANOTEX® WIPES, HALF FOLD, 10" x 12" (60/PACK, 30P/CS)	1800/CS
CN-85341*	EMPTY REUSABLE CANISTER, UNIVERSAL FIT	6/CS

* Wall bracket available

DRY WIPERS

Ideal for critical environments, the sterile and non-sterile high absorbency cleanroom wipes are made from strong and durable fabric with low levels of particles and extractables.

 6.6.3 Introducing products and equipment into the cleanroom

 6.6.4 Cleaning and disinfecting the primary engineering control

STERILE

PROD. #	DESCRIPTION	QTY
CN-C2-99IR/25	STERILESORB™, STERILE, DRY CELLULOSE/POLYESTER, 9" X 9" (25/PACK, 60P/CS)	1500/CS
CN-C2-1212IR	STERILESORB™, STERILE, DRY CELLULOSE/POLYESTER, 12" X 12" (25/PACK, 42P/CS)	1050/CS
CN-NWPZ0001	AMPLITUDE™ KAPPA™, STERILE, NONPYROGENIC LYOCCELL/POLYESTER, 9" X 9" (25/PACK, 40P/CS)	1000/CS
CN-NWPZ0002	AMPLITUDE™ KAPPA™, STERILE, NONPYROGENIC LYOCCELL/POLYESTER, 12" X 12" (25/PACK, 40P/CS)	1000/CS
CN-LWPS0006	POLYNIT HEATSEAL, STERILE, HEAVYWEIGHT TEXTURED POLYESTER KNIT WIPES, 9" X 9" (25/PACK, 48P/CS)	1200/CS
TX-3211	ALPHAWIPE™, STERILE, POLYESTER DRY WIPES, 9" X 9"	500/CS
TX-3212	ALPHAWIPE™, STERILE, POLYESTER DRY WIPES, 12" X 12"	500/CS

NON-STERILE

PROD. #	DESCRIPTION	QTY
CN-AMEC0001	AMPLITUDE™ ECOCLOTH™, HIGH ABSORBENCY CELLULOSE/POLYESTER, 4" X 4" (1200/PACK, 12P/CS)	14400/CS
CN-AMEC0002	AMPLITUDE™ ECOCLOTH™, HIGH ABSORBENCY CELLULOSE/POLYESTER, 6" X 6" (300/PACK, 20P/CS)	6000/CS
CN-AMEC0003	AMPLITUDE™ ECOCLOTH™, HIGH ABSORBENCY CELLULOSE/POLYESTER, 9" X 9" (300/PACK, 12P/CS)	3600/CS
CN-AMEC0004	AMPLITUDE™ ECOCLOTH™, HIGH ABSORBENCY CELLULOSE/POLYESTER, 12" X 12" (150/PACK, 14P/CS)	2100/CS
CN-PN-99	POLYNIT HEATSEAL HEAVYWEIGHT TEXTURED POLYESTER KNIT WIPES, 9" X 9" (150/PACK, 8P/CS)	1200/CS
CN-PN-1212	POLYNIT HEATSEAL HEAVYWEIGHT TEXTURED POLYESTER KNIT WIPES, 12" X 12" (75/PACK, 10P/CS)	750/CS
TX-622	VERSAWIPE® ALL PURPOSE WIPES, CELLULOSE/POLYESTER, 12" X 12" (150/PACK, 10P/CS)	1500/CS
TX-629	VERSAWIPE® ALL PURPOSE WIPES, CELLULOSE/POLYESTER, 9" X 9" (300/PACK, 10P/CS)	3000/CS
TX-624	VERSAWIPE® ALL PURPOSE WIPES, CELLULOSE/POLYESTER, 4" X 4" (1200/PACK, 10P/CS)	12000/CS

STERILE ALCOHOL SWABS

2-ply premium pad sterile material preventing potential for presence of spores. Liberally saturated with 70% isopropyl alcohol.



PROD. #	DESCRIPTION	QTY
BI-63001	WEBCOL™ ALCOHOL PREP PAD MEDIUM (200/PACK, 20P/CS)	4000/CS



QUALITY AND CONTAMINATION CONTROL TOOLS AND CLEANING SOLUTIONS

CLEANING AND DISINFECTANT PRODUCTS

STERILE 70% ISOPROPYL

Meets NAPRA requirements for cleaning biosafety hoods/chemo isolators, gloved hands, products, and equipment.

- Filtered to a 0.2µ and induction sealed to assure sterility
- Double-bagged and gamma-irradiated
- Evaporates, leaves low residuals

- ☞ 6.6.3 Introducing products and equipment into the cleanroom
- ☞ 6.6.4 Cleaning and disinfecting the primary engineering control
- ☞ 6.6.5 Aseptic technique for compounding sterile preparations



PRODUCT #	DESCRIPTION	QTY
CN-HCFT7030IR	STERILE 70% ISOPROPYL ALCOHOL, 30% DI WATER, FLIP TOP, 0.47L	12/CS
CN-SB167030IR	STERILE 70% ISOPROPYL ALCOHOL, SPRAY, 0.47L	12/CS
CN-SB327030IR	STERILE 70% ISOPROPYL ALCOHOL, SPRAY, 0.95L	12/CS
CN-SB1287030IR	STERILE 70% ISOPROPYL ALCOHOL, POLYBOTTLE, 3.8L	4/CS

GERMICIDE³ CLEANER

The most effective broad-spectrum surface disinfectant available.

- Bactericidal, fungicidal, virucidal, tuberculocidal with 3-minute contact time
- Fast, easy, multi-surface cleaning
- For smaller facilities, some products can be purchased in singles

☞ 5.3.4.2 Disinfectant

PROD. #	DESCRIPTION	QTY
GP-GERMI-3-SW	GERMICIDE ³ WIPES CANISTER (160/PACK, 12P/CS)	1920/CS
GP-GERMI-3-SW-R	GERMICIDE ³ WIPES REFILL (160/PACK, 12P/CS)	1920/CS
GP-GERMI-3-SSW	GERMICIDE ³ WIPES CANISTER (60/PACK, 12P/CS)	720/CS
GP-GERMI-3-SSW-R	GERMICIDE ³ WIPES REFILL (60/PACK, 12P/CS)	720/CS
GP-GERMI3-I-XXL	GERMICIDE ³ 3.78L	4/CS
GP-GERMI-3-SW-UN	GERMICIDE ³ UNSCENTED WIPES, 6" X 6.7" (160/PACK, 12/CS)	12/CS
GP-GERMI-3-SW-R-UN	GERMICIDE ³ UNSCENTED WIPES 160 SHEETS/REFILL, 6" X 6.7"	12/CS



DIN #02293072 | DIN #02317842

PERIDOXRTU®

Cost-effective 3-minute non-bleach sporicidal disinfectant and cleaner for pharmacy cleanrooms

- 3-minute sporicide claim at 99.9999% efficacy
- Cleaning and disinfecting PECs according to USP guidelines

 5.3.4.2 Disinfectant

 6.6.3 Introducing products and equipment into the cleanroom



DIN #02456834

PRODUCT #	DESCRIPTION	QTY
CN-HC85365	PERIDOXRTU® SPORICIDAL DISINFECTANT/CLEANER 0.946L (32 OZ)	6/CS
CN-HC85365IR	PERIDOXRTU® SPORICIDAL DISINFECTANT/CLEANER 0.946L (32 OZ) STERILE	6/CS
CN-HC85366	PERIDOXRTU® SPORICIDAL DISINFECTANT/CLEANER 3.8L (1GAL)	4/CS
CN-HC85366IR	PERIDOXRTU® SPORICIDAL DISINFECTANT/CLEANER 3.8L (1GAL) STERILE	4/CS

PHARMA-SURFACE GUARD™

Pharma-Surface Guard™ is a 2-step applicator kit to clean and inactivate cytotoxic agents on chemotherapy work surfaces such as stainless steel. Includes lint-less ISO Class 5 cleanroom grade saturated wipers.

 6.6.3 Introducing products and equipment into the cleanroom



PRODUCT #	DESCRIPTION	QTY
PH-PSG-797	PHARMA-SURFACE GUARD™ (CHEMO HOOD NEUTRALIZER)	15/CS

HAND HYGIENE

ALCOHOL-BASED HAND RUB (ABHR) WITH PERSISTENT ACTIVITY AND NAIL CLEANERS

 6.6.2.1 Hand and forearm hygiene

PRODUCT #	DESCRIPTION	QTY
DL-MMM9200C	AVAGARD™ CHG DISPENSER BOTTLE W PUMP, 500ML	8/CS
DL-MMM9228	AVAGARD™ HANDS FREE WALL DISPENSER FOR 500ML BOTTLE	4/CS
DL-MMM9204C	AVAGARD™ NAIL CLEANERS HIGH QUALITY (150/PACK, 6P/CS)	900/CS
DL-MEDMSC9204	NAIL CLEANERS (150/PACK, 6P/CS)	900/CS
DL-SOL10401	STERIGEL PLUS DISPENSER BOTTLE WITH PUMP, 500ML	12/CS
DL-SOL10403	WALL BRACKET FOR 500ML BOTTLE	EACH
DL-MMM9201C	AVAGARD™ WEDGE WALL BRACKET FOOT PUMP	EACH





QUALITY AND CONTAMINATION CONTROL TOOLS AND CLEANING SOLUTIONS

MOPPING SYSTEM

Mopping system products include extendable handles with reusable mop head frame and disposable wipes that are changed per facility SOPs.

HANDLES

All handles can be used with any Contec Mopping System according to your needs.

PRODUCT #	DESCRIPTION	QTY
CN-2642	QUICKCONNECT HANDLE 16" (40CM) EXTENDS TO 30" (75CM), ANODIZED ALUMINUM	EACH
CN-2643	QUICKCONNECT HANDLE 50" (127CM) EXTENDS TO 92" (234 CM) ANODIZED ALUMINUM	EACH
CN-2644	STAINLESS EXTENSION HANDLE 16" - 30" STAINLESS STEEL	EACH
CN-2725E	QUICKCONNECT™ HANDLE, 60" (152CM), STAINLESS STEEL, LIGHTWEIGHT	EACH

HEAD FRAMES AND COVERS / FLOW HOODS AND ISOLATOR

EasyReach™



EasyReach™ is the ideal cleaning tool to ensure that the head and upper body do not enter the C-PEC.

PRODUCT #	DESCRIPTION	QTY
CN-2665SF	EASYREACH™ CLEANING KIT LIGHTWEIGHT STAINLESS STEEL HANDLE AND MOP HEAD FRAME, 16.5"	EACH
CN-2685	MOP HEAD FRAME STAINLESS STEEL, 7.5"	EACH
CN-PSME0001	CLEANING PADS PRESATURATED, STERILE, 2.75" X 7.75" (8/PACK, 8P/CS)	64/CS
CN-MEQT0001	CLEANING PADS, 2.75" X 7.75" (4/PACK, 15P/CS)	60/CS
CN-MEQT0002	CLEANING PADS, STERILE, 2.75" X 7.75" (4/PACK, 15P/CS)	60/CS

*Recommended handle: CN-2642

Klean Max™

Smaller size designed for small areas such as hoods and isolators

PRODUCT #	DESCRIPTION	QTY
CN-2651SS	VK & VKMAX MOP HEAD FRAME STAINLESS STEEL, 7.5"	EACH
CN-HCKM3001	KLEAN MAX MOP HEAD, SMALL, 8.4" (W) X 4.3" (D) X 0.7" (H) (4/PACK, 12P/CS)	48/CS
CN-HCKM3051	KLEAN MAX MOP HEAD, STERILE, SMALL, 8.4" (W) X 4.3" (D) X 0.7" (H) INDIVIDUAL PACK	48/CS

*Recommended handle: CN-2642



ASK US!



Ask for a customized Live Web Training, broadcast from a cleanroom environment with Contec's experts, on how to use the Contec cleaning tools and accessories.



5.3.4.3 EQUIPMENT USED FOR CLEANING AND DISINFECTION AND ITS STORAGE
6.6.4 CLEANING AND DISINFECTING THE PRIMARY ENGINEERING CONTROL

HEAD FRAMES AND COVERS / CEILINGS - WALLS - FLOORS

Klean Max™

Designed for cleaning and applying disinfectants to both horizontal and vertical surfaces in pharmacy cleanrooms and other critical healthcare environments.

PRODUCT #	DESCRIPTION	QTY
CN-2651SS	QUICKCONNECT™ MOP HEAD FRAME SMALL, 7.5" FOR KLEANMAX	EACH
CN-2652SS	QUICKCONNECT™ MOP HEAD FRAME MEDIUM, 11.5" FOR KLEANMAX	EACH
CN-2652LF	QUICKCONNECT™ MOP COVER FRAME MEDIUM, 11.5" (LAY FLAT FRAME) FOR KLEANMAX	EACH
CN-2652K	QUICKCONNECT™ MOP COVER FRAME MEDIUM, 11.5" (STAR KEEPERS) FOR KLEANMAX	EACH
CN-HCKM3001	KLEAN MAX MOP HEAD, SMALL, 8.4" (W) X 4.3" (D) X 0.7" (H) (4/PACK, 12P/CS)	48/CS
CN-HCKM3051	KLEAN MAX MOP HEAD, STERILE, SMALL, 8.4" (W) X 4.3" (D) X 0.7" (H) INDIVIDUAL PACK	48/CS
CN-HCKM3002	KLEAN MAX MOP HEAD, MEDIUM, 12.8" (W) X 4.3" (D) X 0.7" (H) (4/PACK, 7P/CS)	28/CS
CN-HCKM3052	KLEAN MAX MOP HEAD, STERILE, MEDIUM, 12.8" (W) X 4.3" (D) X 0.7" (H) INDIVIDUAL PACK	28/CS
CN-HCKM3003	KLEAN MAX MOP HEAD LARGE, 15" (W) X 4.3" (D) X 0.7" (H) (4/PACK, 6P/CS)	24/CS
CN-HCKM3053	KLEAN MAX MOP HEAD, STERILE, LARGE, 15" (W) X 4.3" (D) X 0.7" (H) INDIVIDUAL PACK	24/CS
CN-HCKM3004	KLEAN MAX MOP HEAD, SEALED EDGE, MEDIUM, 15" (W) X 5" (D) X 0.375" (H) (4/PACK, 4P/CS)	16/CS
CN-LWMM0300	MICROGENESIS MICROFIBER WIPE, 10" X 18" (100/PACK, 4P/CS)	400/CS

*Recommended handles: CN-2725E or CN-2643 for high ceilings

QuickKlean™ with MicroGenesis™

The combination of the lightweight, easy-to-maneuver hardware and particle pick-up capacity of the MicroGenesis™ microfiber wipe delivers unprecedented performance.

PRODUCT #	DESCRIPTION	QTY
CN-2745	QUICKKLEAN MOP HEAD FRAME, BLUE POLYPROPYLENE, 16"	EACH
CN-TASK0100	QUICKKLEAN FOAM MOP HEAD (4/PACK, 8P/CS)	32/CS
CN-LWMM0400	QUICKKLEAN KIT (INCLUDES 100 MICROGENESIS WIPES AND 6 MOP HEADS)	EACH
CN-LWMM0300	MICROGENESIS MICROFIBER WIPE, 10" X 18" (100/PACK, 4P/CS)	400/CS

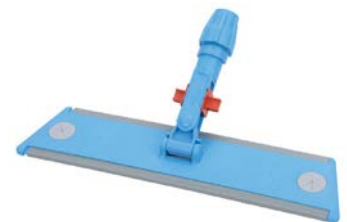

*Recommended handle: CN-2725E

Microcinch™

CN-HCPH8007

Microcinch™ Mop is constructed of 100% synthetic microfiber that provides superior removal of gross soil and fine particulate. The sealed edge "pocket" style design allows for quick changing of mop heads.

PRODUCT #	DESCRIPTION	QTY
CN-2740	MICROCINCH FLAT HINGED MOP HEAD FRAME, BLUE POLYPROPYLENE	EACH
CN-HCPH8007	MICROCINCH FLAT HINGED MOP HEAD FRAME, STAINLESS STEEL	EACH
CN-HCPM5001	MICROFIBER MOP COVER WITH POCKETS, 5" X 15.5" (8/PACK, 15P/CS)	120/CS
CN-HCPM5051	MICROFIBER MOP COVER, STERILE (7/BAG, 5B/PACK, 2P/CS)	70/CS



*Recommended handles: CN-2725E or CN-2643 for high ceilings



QUALITY AND CONTAMINATION CONTROL

QUALITY CONTROL INSTRUMENTS AND TESTS

ENVIRONMENTAL MONITORING

ENVIROTEST®

EnviroTest® is suitable for both surface sampling as well as gloved fingertip and thumb sampling. The rectangle shape of the device allows for easy sampling of areas frequently missed by circular style plates such as edges, corners, and latch handles.

7.3.2.3 Environmental verification

PROD. #	DESCRIPTION	QTY
QI-ET1000	DOUBLE SIDED TSA (TRYPTICASE SOYAGAR) WITH POLY 80 & LECITHIN	10/CS
QI-ET3000	ENVIROTEST™ MEDIA PLATES DOUBLE SIDED MEA (MALT EXTRACT AGAR)	10/CS



TRIO.BAS™ Biological Air Sampler

The TRIO.BAS™ air samplers have a 35-year history and are designed by the engineers who developed the first portable air sampler. The instruments are lightweight, ergonomic, have data integrity with Bluetooth capability and use standard media.

We have selected the MONO and DUO kits that best fit the cleanroom environmental monitoring needs.

5.3.3.1 Primary engineering control

7.3.1 Verification of equipment supporting compounding activities

* Requires purchase of software BAS295 for electronic data transfer via included cable

PRODUCT #	DESCRIPTION	QTY
HY-BAS211K*	TRIO.BAS™ MONO KIT, WITH DATA TRANSFER CABLE, 100L/MIN., CONTACT PLATE	EACH
HY-BAS212K*	TRIO.BAS™ MONO KIT, WITH DATA TRANSFER CABLE, 100L/MIN., PETRI PLATE	EACH
HY-BAS213K*	TRIO.BAS™ MONO KIT, WITH DATA TRANSFER CABLE, 200L/MIN., CONTACT PLATE	EACH
HY-BAS214K*	TRIO.BAS™ MONO KIT, WITH DATA TRANSFER CABLE, 200L/MIN., PETRI PLATE	EACH
HY-BAS222K*	TRIO.BAS™ DUO KIT WITH DATA TRANSFER CABLE, 100L/MIN., CONTACT PLATE	EACH
HY-BAS223K*	TRIO.BAS™ DUO KIT, WITH DATA TRANSFER CABLE, 100L/MIN., PETRI PLATE	EACH
HY-BAS231K*	TRIO.BAS™ DUO KIT, WITH DATA TRANSFER CABLE, 200L/MIN., CONTACT PLATE	EACH
HY-BAS232K*	TRIO.BAS™ DUO KIT, WITH DATA TRANSFER CABLE, 200L/MIN., PETRI PLATE	EACH
HY-BAS295	SOFTWARE ASPC DOWNLOAD ALT TO ANDROID APP EA	EACH
HY-P740	TSA (TRYPTIC SOY AGAR) WITH LECITHIN AND TWEEN® 80, USP FOR THE CULTIVATION AND ENUMERATION OF MICROORGANISMS. IRRADIATED, TRIPLE BAGGED, 0.59" X 2.36"	10/CS
HY-P750	SABDEX (SABOURAUD DEXTROSE) AGAR WITH LECITHIN & TWEEN® 80, USP FOR THE CULTIVATION OF FUNGI. IRRADIATED, TRIPLE BAGGED, 0.59" X 2.36"	10/CS
HY- W1670	TRYPTIC SOY AGAR (TSA), STEREM™, IRRADIATED, USP, TRIPLE BAGGED, 0.59" X 3.93" PLATE, 26ML FILL	10/CS
HY- W1770	SABDEX (SABOURAUD DEXTROSE) AGAR, USP, STEREM, IRRADIATED, TRIPLE BAGGED, 0.59" X 3.93" PLATE, 26ML FILL	10/CS

SURFACE SAMPLING

SAFECHEMO™

The kit includes everything to collect up to 12 samples and analyze up to 15 compounds per sample. (up to 1000 different compounds are possible)

Over a million analyses performed since 1982. Using the SafeChemo™ kit, you can accurately sample and measure HD surface concentrations and address NAPRA compliance, safeguarding patients, employees and the environment.

- 5-Fluorouracil
- Busulfan
- Carboplatin
- Cisplatin
- Cyclophosphamide
- Cytarabine
- Daunorubicin
- Docetaxel
- Doxorubicin
- Etoposide
- Ifosfamide
- Methotrexate
- Oxaliplatin
- Paclitaxel
- Vincristine
- Gemcitabine

7.3.2.3 Environmental verification

PRODUCT #	DESCRIPTION	QTY
AA-SSK01	SAFECHEMO™ SURFACE SAMPLING KIT	EACH



END PRODUCT TESTING

QUICKTEST® SYSTEM

For compounding facilities utilizing automated compounding devices (ACD), Q.I. Medical patented the QuickTest® System process validation test. The QuickTest® is used to test IV admixtures for the presence of microbial contamination.

PRODUCT #	DESCRIPTION	QTY
QI-QT1000	CONTAMINATION TESTER FOR USE WITH <ul style="list-style-type: none"> • ADCOMP™ COMPOUNDER • AUTOMIX COMPOUNDER (CLINTEC) • AUTOCOMP 6™ COMPOUNDER • EXACTA-MIX™ COMPOUNDER (BAXA) • NUTRIMIX™ COMPOUNDER (ABBOTT) 	10/CS
QI-QT1100	CONTAMINATION TESTER WITH UNIVERSAL SPIKE AND 18" EXTENSION SET FOR USE WITH <ul style="list-style-type: none"> • VACUUM BOTTLES • VACUUM BELLS • GRAVITY FILTRATION OF CLEAR ADMIXTURES 	10/CS
QI-QT2000	100ML BAGS CONTAMINATION TESTER FOR USE WITH ANY PUMP SET WITH MALE LUER CONNECTOR, SUCH AS THE PHARMASSIST AND BAXA REPEATER PUMPS	10/CS



QI-QT1000



YOU MAY ALSO LIKE
 TOOLS AND CLEANING SOLUTIONS
 CLEANROOM SPILL KIT | PAGE 27



END PRODUCT TESTING

QT JUNIOR®

Full filtration system for testing large and small volume sterile admixtures. In addition to the QT Micro system, another membrane filtration sterility test option for both small and large volume sterile admixtures is the QT Junior system.



QI-TJ3200

 6.1.3 Beyond-use dates according to risk of microbial contamination

PRODUCT #	DESCRIPTION	QTY
QI-TJ3100	CONTAMINATION TESTER WITH 0.22µ MEMBRANE, UNIVERSAL SPIKE INLET AND MALE LUER OUTLET	20/CS
QI-TJ3200	CONTAMINATION TESTER WITH 0.22µ MEMBRANE, UNIVERSAL SPIKE INLET AND SPIKE SEPTUM OUTLET	20/CS

TUFFTEST 2®

For solutions where sterility testing is required, but membrane filtration is not feasible, the TuffTest 2 is available for using the direct inoculation method.



 6.1.3 Beyond-use dates according to risk of microbial contamination

PRODUCT #	DESCRIPTION	QTY
QI-GM8100	TUFFTEST2™ CONTAMINATION TESTER, 100ML TSB WITH TSA IN STERILE PLASTIC BOTTLE, NEEDLE ACCESS PORT	4/CS

QT MICRO®

For small volumes formulations up to 120cc and is an ideal choice for affordable in-house sterility testing. The QT Micro is a non-destructive FDA licenced membrane filtration test kit available with both USP <71> required media (TSB and FTM).



QI-TM6000

 6.1.3 Beyond-use dates according to risk of microbial contamination

PROD. #	DESCRIPTION	QTY
QI-TM6000	0.22µ CONTAMINATION TESTER, FEM. LUER LOCK INLET, FEM. LUER LOCK OUTLET. KIT CONTAIN 1 TEST & 1.5ML SYRINGE MEDIA	10/CS
QI-TM6001	0.22µ CONTAMINATION TESTER, FEM. LUER LOCK INLET, FEM. LUER LOCK OUTLET, FTM MEDIA	10/CS
QI-TM6100	0.22µ CONTAMINATION TESTER, FEM. LUER LOCK INLET, MALE LUER SLIP OUTLET. KIT CONTAIN 1 TEST & 1.5ML SYRINGE MEDIA	10/CS
QI-GM0203	FLUID D, 20ML VIAL, NEEDLE/SPIKE SEPTUM	20/CS

YOU MAY ALSO LIKE
TOOLS AND CLEANING SOLUTIONS
CLEANING AND DISINFECTANT PRODUCTS | PAGE 30



STAFF VALIDATION



QI-GM0200

GROMED™ IV Validation Medium

We offer a wide-range line of GroMed media components as well as prepackaged kits that mimic common manipulations found in a pharmacy setting for all risk levels (low, medium, high).



PROD. #	DESCRIPTION	QTY
QI-GM0030	TSB MEDIA, 3ML GLASS AMPOULE	20/CS
QI-GM0252	TSB 2X MEDIA, 25ML VIAL	10/CS
QI-GM0100	TSB MEDIA, 10ML TUBE, SCREW CAP & NEEDLE ACCESS PORT	20/CS
QI-GM0200	TSB GROWTH MEDIA, 20ML VIAL, NEEDLE/SPIKE SEPTUM	20/CS
QI-GM0101	FLUID THIOGLYCOLLATE MEDIA, 10ML TUBE, SCREW CAP & NEEDLE ACCES PORT	20/CS
QI-GM0201	FLUID THIOGLYCOLLATE MEDIA, 20ML VIAL WITH NEEDLE SEPTUM PORT	10/CS
QI-GM2001	FLUID THIOGLYCOLLATE MEDIA, 100ML VIAL WITH SEPTUM FOR NEEDLE OR DISPENSING PIN ACCESS	10/CS
QI-GM1400	TSB GROWTH MEDIA, 100ML BAG WITH NEEDLE ACCESS PORT AND SPIKE PORT	10/CS
QI-GM1500	TSB MEDIA, 100ML BAG, MALE LUER CONNECTOR AND SPIKE PORT	10/CS
QI-GM2000	TSB GROWTH MEDIA, 100ML VIAL WITH SEPTUM FOR NEEDLE OR DISPENSING PIN ACCESS	10/CS
QI-GM3000	SOYBEAN-CASEIN DIGEST MEDIA, 3GRAM FOIL POUCH. RECONSTITUTES TO CREATE 100ML OF TSB MEDIA	20/CS
QI-GM4000	POTATO DEXTROSE AGA SLANT(PDA), 10ML TUBE, TEST FOR FUNGAL CONTAMINATION	20/CS
QI-GM5000	TSB GROWTH MEDIA, 500ML BAG, 1X STRENGTH, BREAKAWAY COVERED NEEDLE ACCESS PORT	10/CS
QI-GM6005	TSB MEDIA, 5CC PREFILLED IN 12CC LUER LOCK SYRINGE	10/CS
QI-GM6105	FLUID THIOGLYCOLLATE MEDIA, 5CC, PREFILLED IN 12CC LUER LOCK SYRINGE	10/CS

Aseptic Technique Test Kit

PROD. #	DESCRIPTION	QTY
QI-GM7020	PATT™, PERSONAL ASEPTIC TECHNIQUE TEST KIT, 20ML VIALS, 100ML PARTIALLY FILLED MINIBAGS, TEST PROCEDURE & RESULTS LOG	5/CS
QI-GM7030	PATT2™, PERSONAL ASEPTIC TECHNIQUE TEST KIT, 3ML AMPOULES, 20ML VIALS, 100ML PARTIALLY FILLED MINIBAGS, TEST PROCEDURE AND RESULTS LOG	5/CS



QI-GM7030



QI-CT9530

CHEMOTEST® Hazardous Drugs Preparation Validation Medium

The ChemoTest kit is an excellent test to validate the technique of personnel who manipulate hazardous drugs, it can also be utilized as a spill cleanup validation test.



PROD. #	DESCRIPTION	QTY
QI-CT9530	15 50ML VIALS POWDERED FLUORSCIENCE DYE, 5 3ML VIALS OF LIQUID FLUORSCIENCE DYE	5/CS
QI-CT9000	MINI ULTRAVIOLET LIGHT, FOR USE WITH CHEMOTEST	EACH



QUALITY AND CONTAMINATION CONTROL

QUALITY CONTROL INSTRUMENTS AND TESTS

STAFF VALIDATION

WIZARD™ Bubble Point Tester and Syringe Filters

Filters used to sterilize pharmaceutical fluids must be approved for human-use and be pyrogen free with an anominal pore size of 0.2μ or 0.22μ. We offer the PALL HP1002 0.22μ sterilizing filters.

Filter integrity testing is also required following the sterilizing process. The Bubble Point test is designed to show that consistent flow of air will not occur through the filter prior to the manufacturer’s listed “bubble point.” The PG005 performs this filter integrity testing.



QI-PG005

 7.4.2 Media fill test

PRODUCT #	DESCRIPTION	QTY
MD-HP1002	0.22μ FILTER, STERILE, FEMALE LUER LOCK INLET, MALE LUER LOCK OUTLET, HYDROPHILIC, 25MM	50/CS
QI-PG005	BUBBLE POINT TESTER FOR USE WITH SYRINGE FILTERS, 0-100 PSI RANGE <ul style="list-style-type: none"> • 1 REOTEMP CALIBRATED • PRESSURE GAUGE • 1 SYRINGE • 1 LENGTH OF TUBING 	EACH

INCUBATORS



We offer two models of analog incubators from Quincy Labs. Additional models available upon request.

 5.3.3.2 Other devices, instruments or accessories related to the compounding of non-hazardous sterile preparations

PRODUCT #	DESCRIPTION	QTY
QL10-140	INCUBATOR 13" (W) X 11" (D) X 15" (H), 0.7" ²	EACH
QL12-140	INCUBATOR 19" (W) X 13" (D) X 21" (H), 2.0" ²	EACH

YOU MAY ALSO LIKE

QUALITY CONTROL INSTRUMENTS AND TESTS
TRIO.BAS, BIOLOGICAL AIR SAMPLER | PAGE 34





MEDICATION PACKAGING AND AUTOMATION

ORAL UNIT AND MULTI-DOSE PACKAGING SOLUTIONS

PACKAGING AUTOMATION

AUTO-PRINT® Unit-Dose Packaging System

Auto-Print® Unit-Dose Packaging System is a complete bar-coding packaging solution for oral solid medications. This high-performance, durable system eliminates the need for manual packaging and sorting of medication and is designed for simple maintenance and easy operation.

- Produces up to 60 packages per minute
- Includes custom Pak-EDGE™ Barcode Labelling Software
- Standard package size is 2" x 1.5", custom packaging option down to 1.5" x 1.5" to accommodate smaller Automated Dispensing Cabinet (ADC) size
- The optional variable length feature adds the capability to change the package length in real time. (1", 1.12", 1.25", 1.37", 1.5", 1.87", 2.25")

FUNCTION	SPECIFICATIONS
DIMENSION	36" (W) X 15" (D) X 14" (H)
WEIGHT	65 LB
POWER	115 VAC 50 HZ OR 230 VAC 60 HZ, 320 VA
SEALING TEMP	200°F, NO DEGRADATION TO MEDICATION, NO FUMES
LENGTH AVAIL.	1", 1.12", 1.25", 1.37", 1.5", 1.87", 2.25"

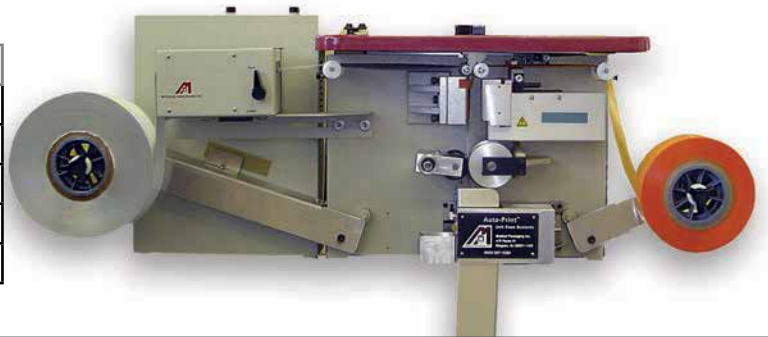

AUTO-PRINT® Oral Solid Feeder (OSF)

Oral Solid Feeder (OSF) attaches to the Auto-Print™ to automate feeding of pills. Bulk medication is loaded into the feeder which will automatically feed the medication one at a time until all medications have been packaged, eliminating the need for manual hand feeding by the pharmacy technician for increased efficiency.

FUNCTION	SPECIFICATIONS
SIZE	15.5" (W) X 8.5" (D) X 3" (H)
WEIGHT	7 LB
POWER	115/230VAC, 50/60HZ, 70VA



AUTO-PRINT® Bagging System

The Auto-Print® bagging system is a bar-coding packaging solution for ampoules, vials and syringes. This solution provides the capability of loading, printing, bar-coding, and sealing medications in a few simple steps.



MEDICATION PACKAGING AND AUTOMATION

ORAL UNIT AND MULTI-DOSE PACKAGING SOLUTIONS

PACKAGING AUTOMATION

ATP®2 SERIES

The ATP®2 has once again leaped ahead of all the others in reliability, longevity, and features to drive efficiency and growth for our pharmacy partners. The ATP®2 is the industry's most comprehensive and accurate Rx packaging system.

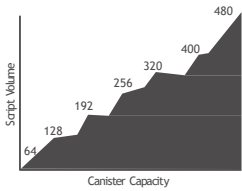

EXPANDABILITY

Scalable machine grows as needs dictate canister sizes (64, 128, 192, 256, 320, 400, and 480). ATP®2 Mini available for smaller pharmacies.



POUCH VARIETY

Choose between four pouch sizes. Narrow and Wide packaging options available to meet your unit-dose or multi-dose needs.



GRAPHIC PRINTING

The most sophisticated printing on the market. Colour and vertical printing, pictures, barcodes, logos, icons, variable fonts and sizes are available through the easy-to-use label software.



DUAL TRAY SYSTEM

The only system that includes two integrated trays to continuously run exception drug filling without interruption.



REDUNDANT LOWER PACKAGER

Swappable lower packaging unit (LPU) allows for the majority of hardware issues to be resolved in a matter of minutes.

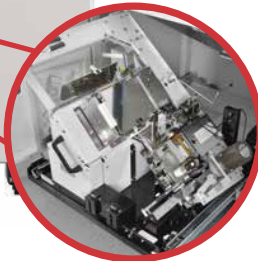

ATP®2 480

THE ONLY MACHINE TO FIT ALL YOUR NEEDS



AUTOSENSE™ SMART CANISTERS *

The software will direct the user to add or remove the canister based on the order formulary.



CANISTER CALIBRATION KIT *

Manage drug changes more efficiently by recalibrating your canisters in house.



1/2 TAB CANISTER DISPENSING *

Allows for certain high-volume 1/2 tabs to be run through canisters.



Combine the ATP®2 with the InspectRx™ for a complete verification.



The ATP®2 will improve your pharmacy workflow and increase throughput.

TESTIMONIAL

With the ATP®2 and InspectRx® we have enhanced our patient safety practices by having full traceability of medications to the bedside. We have been able to accomplish this and at the same time increase our productivity.

Edith Rolko B.Sc.Pharm R.Ph.

Director of Pharmacy

Adjunct Professor, Leslie Dan Faculty of Pharmacy, North York General Hospital, Toronto

*Accessory option not included in base system



SAFETY



ACCURACY

EFFICIENCY



RELIABILITY



COST-EFFECTIVENESS



NAPRA COMPLIANT



SAFE FOR CHEMOTHERAPY

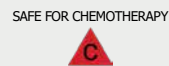



MEDICATION PACKAGING AND AUTOMATION

ORAL UNIT AND MULTI-DOSE PACKAGING SOLUTIONS

PACKAGING AUTOMATION

ATP® 2 SERIES ADDITIONAL ACCESSORIES



SMART TRAY RX™ LIGHTED TRAY FILLING SYSTEM (ULT-100)

The optional lighted tray system allows users to fill and check using barcode validation, light direction, and colour-coded reminders. Barcode scanning throughout the fill ensures the right drug and tray are being used for each batch.

SmartTrayRx™ is accurate, productive, paperless and safe.



SPOOLERS AND WINDERS

Automatically or manually spool pouches during the filling and checking process. Preserve the integrity of pouch strips, move, and store pouches from the ATP®2 with ease.



BULLSEYE® TABLET SPLITTER

Automatically cut tablets in half reducing damaged pills and providing more accurate doses to patients. When used in conjunction with the ATP®2 and InspectRx®, the BullsEye® reduces errors flagged in the tray fill or image verification process.

ATP® 2 SERIES SPECIFICATIONS

FUNCTION	SPECIFICATIONS
DIMENSION FOOTPRINT	<320 CABINET: DOORWAY: 41" (W) X 31" (D) X 80" (H), INSTALLED: 41" (W) X 31" (D) X 86" (H) 400 CABINET: DOORWAY: 41" (W) X 31" (D) X 80" (H), INSTALLED: 52" (W) X 31" (D) X 86" (H) 480 CABINET: DOORWAY: 41" (W) X 31" (D) X 80" (H), INSTALLED: 63" (W) X 31" (D) X 86" (H)
NET WEIGHT	1279 LB. (UP TO 320 SIZE) / 1620 LB. FOR 400 / 1962 LB. FOR 480 (APPROXIMATE, WITHOUT CANISTERS)
POWER SOURCE	115 VAC, 465W, 4.04 AMPS (AVERAGE)
NUMBER OF CANISTERS	CONFIGURABLE 64, 128, 192, 256, 320, 400 OR 480
CANISTER CAPACITY	350CC (APPROXIMATE)
CANISTER TYPES	PINNED OR AUTONSENSE™ SMART
PACKAGE TYPE (H X W)	NARROW UNIT-DOSE (23.62" X 16.92") AND UNIT-DOSE/MULTI-MED (21.65" X 29.13", 31.5" X 29.13", 33.46" X 29.13")
PACKAGING SPEED	UP TO 60 BAGS/MINUTE
EXTERNAL TRAY	(2) 64-CELL TRAYS ACCOMMODATE MULTIPLE MEDS IN EACH CELL
TOUCH SCREEN	MOUNTABLE, LEFT AND RIGHT
BARCODE VERIFICATION	PDF 417, DATA MATRIX, QR CODE, AZTEC, BARCODE 128, BARCODE 3 OR 9, UPC
SAFETY STANDARD	CUL, UL (UL61010-1)

POUCH VERIFICATION

INSPECTRX® POUCH VERIFICATION SYSTEM

InspectRx® is an innovative system of imaging and medication pouch analysis for use with the ATP®2 Series. Manual checking of pouches is greatly reduced through electronic sorting and analysis to ensure that the right pill is in the right pouch for the right patient. InspectRx® closes the loop on quality control and communication with your staff and facilities.

DESIGN FEATURES

- Three processing models:
Inspect24 – 2400 pouches/hr.
Inspect36 – 3600 pouches/hr.
Inspect54 – 5400 pouches/hr.
- New multiple spectrum analysis camera
- Login security
- On-the-fly referencing imaging streamlines database maintenance
- Analysis of each pill using 12 different parameters
- Accommodates pharmacies using both unit-dose and multi-dose packages

ACCURACY AND SAFETY

- Provides a fast electronic view of each pouch
- Analysis by visual and electronic verification
- Colour indicators flag suspect pouches
- Corrected pouches are photographed and uploaded to database
- Image retention for documentation audits from healthcare inspectors
- Pharmacy has full control of image database

LABOUR SAVINGS

- Decreases labour costs of manually handling pouches
- Significant reduction in pharmacist check time
- Streamlines and automates collation process when combined with Collector™

SPEED

- 2400, 3600 or 5600 pouches per hour
- Includes a secondary external camera to reduce downtime associated with pouch rework





MEDICATION PACKAGING AND AUTOMATION

ORAL UNIT AND MULTI-DOSE PACKAGING SOLUTIONS

POUCH VERIFICATION

INSPECTRX® Visual Confirmation

ELECTRONIC INSPECTION

The InspectRx™ technology photographs the front and back of each pouch. The images are analyzed to distinguish the physical characteristics of medications using 12 different parameters, including:

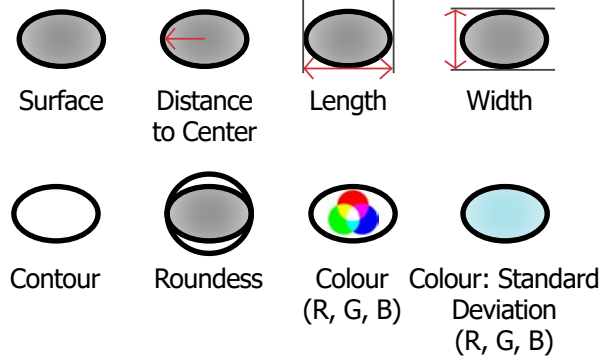

- Key**
- A. Work que
 - B. Customizable
 - C. Large images showing previous and following pouches
 - D. Dashboard of reference images
 - E. Track and trend production issues for continuous improvement
 - F. Display by pass time
 - G. Display by day



CORRECTOR STATION

Each InspectRx™ includes a Corrector Station. This external photo station facilitates the correction and documentation of any pouches requiring attention.

FUNCTION	SPECIFICATIONS
SIZE	75"W × 26"D × 57"H; 112"W × 26"D × 57"H (INCLUDING COLLECTOR)
WEIGHT	374 LB.; 814 LB. (INCLUDING COLLECTOR)
SPEED	INSPECT 24 – 2,400 POUCHES/HR. INSPECT 36 – 3,600 POUCHES/HR. INSPECT 54 – 5,400 POUCHES/HR.
POWER SOURCE	110V, 60HZ, 12 AMP & GROUND

PARATA PERL® Pouch Inspector

Parata Perl® is designed to combine a visual inspection system with the speed, compact size, scalability, and price tag that makes sense for your pharmacy. Parata Perl® sees and interprets medications in pouch packaging more than 3x faster than the competition and with higher accuracy.

- 

With two powerful, HD video cameras, Perl® images and identifies the content of each pouch.
- 

Parata Perl® inspects up to 5 pouches per second, making it the fastest pouch inspection technology on the market.
- 

Perl® keeps up with your growing business; upgrade from Perl® to Perl® Plus anytime for faster processing speeds and more user licences.

SMART AND COMPACT

On-the-fly referencing will allow users to update the database without stopping production. The Perl® can be placed on a standard pharmacy countertop.



FUNCTION	SPECIFICATIONS
SIZE	21.5"W × 12.5"D × 26.25"H; 42"W × 12.5"D × 26.25"H (INCLUDING SPOOL)
WEIGHT	48 LB.
SPEED	PERL® INSPECTS 1 POUCH PER SECOND (INCLUDES 2 USER LICENCES) PERL® PLUS INSPECTS UP TO 5 POUCHES PER SECOND (INCLUDES 5 USER LICENCES)
POWER SOURCE	120V, 60HZ, 15 AMP, STANDARD OUTLET
NETWORK REQUIREMENTS	ETHERNET RJ-45 (CAT VI)



SAFETY



ACCURACY



EFFICIENCY



RELIABILITY



COST-EFFECTIVENESS



NAPRA COMPLIANT

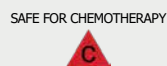

SAFE FOR CHEMOTHERAPY



MEDICATION PACKAGING AND AUTOMATION

ORAL UNIT AND MULTI-DOSE PACKAGING SOLUTIONS

INTELLIGENT PHARMACY ONLINE SOFTWARE

PHARMALYTICS™

PharmAlytics, TCGRx's web-based business intelligence, provides actionable information to increase the pharmacy's productivity and optimize inventory with TCGRx's ATP®2 and Beacon® solutions.

- Access to vital system performance parameters, wherever you are
- Proactive email notifications if system parameters exceed the alert threshold
- Adjustable thresholds based on business requirements
- View the performance of multiple sites on one screen
- Set various permission levels for users



Improved productivity



Lower operating costs

HeartBeat Overview

PharmAlytics provides an overview of the TCGRx solutions of a single pharmacy location or multiple pharmacy systems.

- Green** = Meets or exceeds goals
- Yellow** = Exceeds alert thresholds
- Red** = Between goal and alert threshold

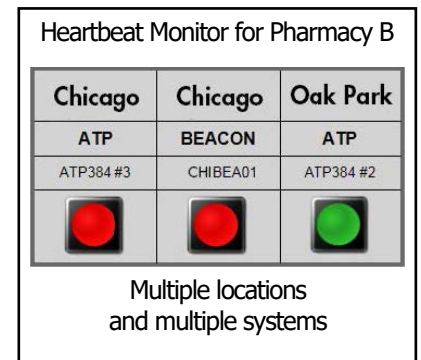
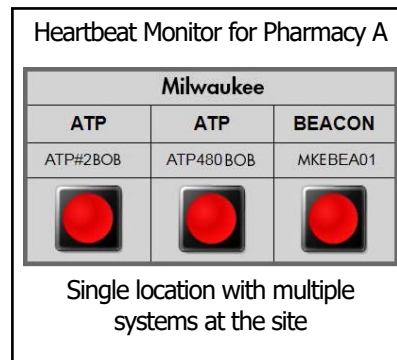

Increase Productivity

Monitoring productivity and idle time is key to continuous productivity improvement. Identifying the leading causes of lost productivity leads to improved automation utilization.

- Bag production time (per hour)
- Idle time (per day) - factors that feed into this metric include tray setting, canister filling, over-dispense alarms, and no activity.

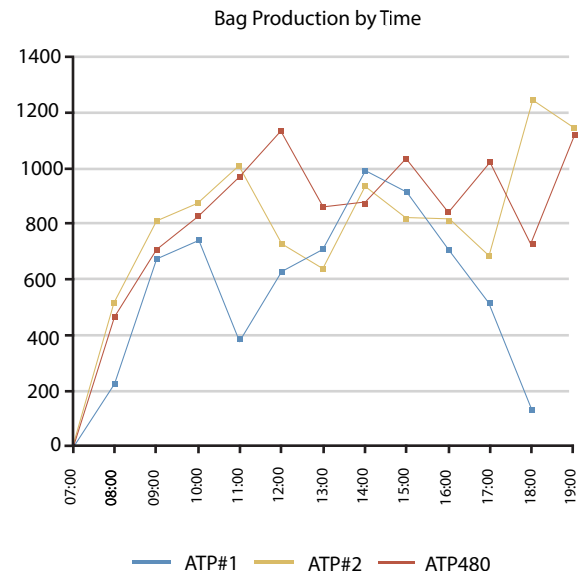
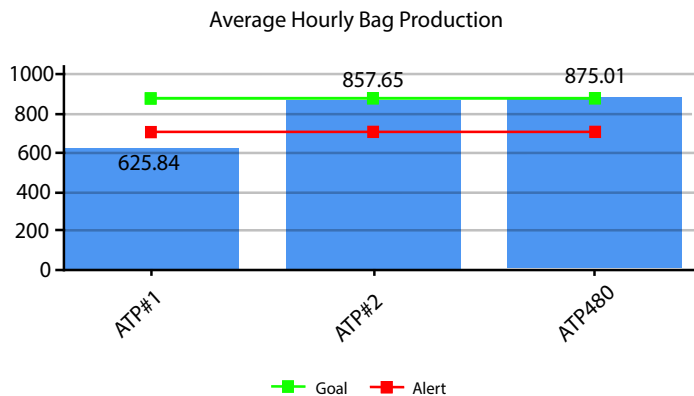

Utilization Optimization

Calculated based on a user-defined period, Pharmalytics™ recommends changes for which medication to put into canisters or trays and the canister placement in the ATP®2. Maximize canister usage by

- Relocating the fastest-moving medication canisters for minimal drop time into pouches
- Move low volume medications to trays and higher-used meds to canisters to reduce labour
- Grouping canisters of high usage, large pills to reduce canister fills and lessen down time

Quality Assurance

Pharmalytics provides the ability to audit canister quality trends for continuous improvement. Three quality metrics are analyzed:

- Soon to expire meds (within 30 days)
- Expired meds – visibility to meds that are expired so they are not dispensed.
- Over-dispensing – several factors affect over-dispensing including: the canister needing replacement, canister recalibration, or the med should be trayed versus placed in canisters

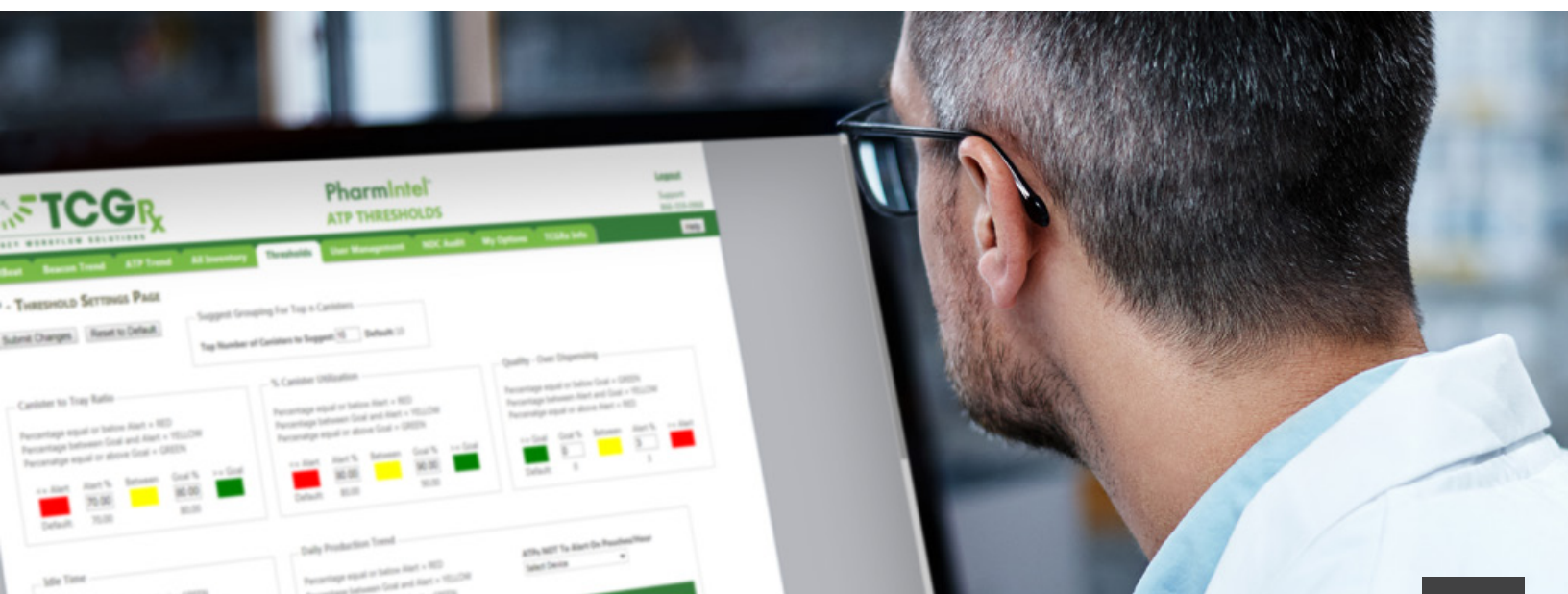



MEDICATION PACKAGING AND AUTOMATION

LIQUID PACKAGING SOLUTIONS

LIQUID AND SYRINGE FILLING AUTOMATION

FLUIDOSE® Unit-Dose Packaging System

Fluidose® Unit-Dose Packaging System with a built-in syringe pump mechanism is an automated, barcoding packaging solution for unit-dose oral liquid medication. This solution assists the pharmacy in decreasing packaging costs, increasing operational efficiency, and reducing medication errors.

Decrease Costs

Automatic packaging of bulk liquid medication into unit-dose is most cost efficient for batch size packaging. 12-month expiration from date of packaging extends the usable shelf life of medication.

Increase Operational Efficiency

Produces up to 15 doses per minute depending on fill rate. Cups are available in four different sizes of standard blue colour (7ml, 15ml, 25ml, and 35ml) and also red for controlled or specialty medications. All materials qualify for light-resistant packaging per USP.

FUNCTION	SPECIFICATIONS
DIMENSION	32" (W) X 14" (D) X 18" (H)
WEIGHT	125 LB
POWER	115VAC, 60HZ, 400VA 230VAC, 50/60HZ, 400VA
SEALING TEMP	220° C

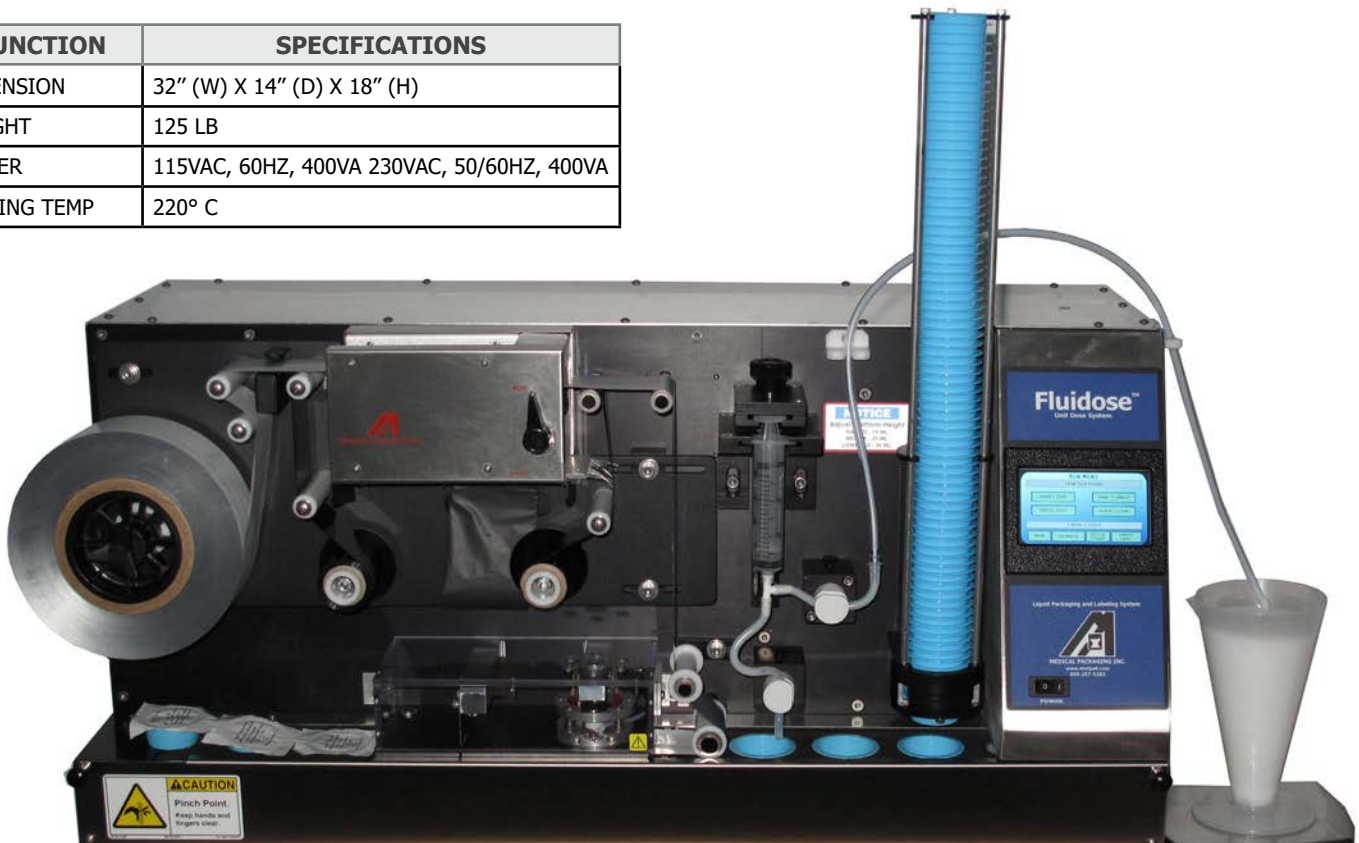

YOU MAY ALSO LIKE

ORAL UNIT AND MULTI-DOSE PACKAGING SOLUTIONS
AUTO-PRINT®, UNIT-DOSE PACKAGING SYSTEM | PAGE 39



SMARTPHARMA

SmartPharma automated filling system is designed for batch preparations of syringes and IV minibags. The SmartPharma equipment line is designed for use in cleanrooms, LAF hoods, and isolator environments.

These systems assist in meeting USP <797> requirements. The SmartPharma product line by CARGIN will assist in providing better quality and reduce the risk of contamination. The system will reduce the risk of fatigue, filling errors, and labour costs.

Completely customizable for your filling, capping, labeling, and verification needs.

- This unit can fill 0.5mL to 60mL syringes.
- Lightweight, flexible robot arms
- Stationary or mobile platform
- Simple touch screen interface
- Plug-and-Play set-up
- Fast set-up
- Easy programming
- Space-saving design

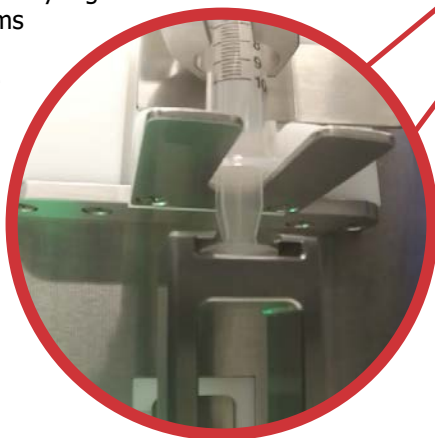

Sealed sterile system



Accurately fill syringes from 0.5mL to 60mL



SAFETY



ACCURACY



EFFICIENCY



RELIABILITY



COST-EFFECTIVENESS



NAPRA COMPLIANT



SAFE FOR CHEMOTHERAPY





MEDICATION PACKAGING AND AUTOMATION

LIQUID PACKAGING AUTOMATION

LIQUID AND SYRINGE FILLING AUTOMATION

PHARMASSIST™ Dispensing Repeater Pump

The PharmAssist™ Dispensing Repeater Pump is ideal for CIVA batching of antibiotics including reconstitution into bulk gram vials and filling minibags or syringes. PharmaAssist™ can also be paired with a user-friendly printer.

- Internal memory
- Various types of sets, tubing, and accessories.
- Vertical placement of roller head to avoid spill damage



PRODUCT #	DESCRIPTION	QTY
EX-SP1000	PHARMASSIST AUTOMATED DISPENSING PUMP	EACH
EX-SH01	SYRINGE FILLING HOLDER BLOCK	EACH
EX-SA250	SYRINGE FILLING ADAPTOR	250/CS
EX-GT01	GLASS TIP FOR ORAL LIQUID TUBING SET	EACH
EX-PRINT	THERMAL LABEL PRINTER	EACH
TM-TPC	HAND-HELD THERMAL LABEL APPLICATOR	EACH
EX-PAB-#COLOUR	THERMAL LABELS/ROLL, YELLOW OR BLUE	16 ROLLS
EX-DOT	THERMAL DOT LABELS 2000/ROLL, YELLOW	16 ROLLS
AC-PHARM6FG	SINGLE LEAD PUMP SET (WITH FINGER GRIP FOR FILLING MINIBAGS)	50/CS

PHARMACY WEIGH SCALE

Portable top-load weigh scale for standard pharmacy procedures. High quality performance and value. Additional models available from 120g to 6100g.

PRODUCT #	DESCRIPTION	QTY
AC-EJ200	210 GRAM CAPACITY (± 0.01 GRAM ACCURACY)	EACH
AC-EJ-4100	4100 GRAM CAPACITY (± 1 GRAM ACCURACY)	EACH

PRECIFILL™ Oral Liquid Filling Pump

The Precifill™ Dispensing Pump is designed to accurately fill oral liquid syringes, minibags, or unit-dose pots (vials) regardless of viscosity. This simple to use pump replaces hand filling and reduces the potential for repetitive strain injuries.



- Fills oral liquid syringes or IVs with high-precision accuracy $\pm 1\%$ (volumes $>1\text{ml}$) and $\pm 2\%$ (volumes $<1\text{ml}$)
- Accurate filling of volumes as low as 0.2ml and syringe sizes as small as 1ml



COMPOUNDING AND MIXING DEVICES

THE SEVERO Electric Pill Crusher

Severo grinds pills to fine powder in seconds. When swallowing of pills is difficult, the Severo electric pill grinder is the best and safest solution for patients and healthcare professionals. It is widely used in hospitals, nursing homes, pharmacies, and veterinary clinics around the world where medicine intake is a problem and efficiency and safety a priority.

- Prevention of repetitive strain injury
- No more exposure to medication dust
- No more spills and cross-contamination
- Near silent crushing
- Ideal for administration via feeding tubes
- Fast and easy to use
- Can be mounted on carts

PRODUCT #	DESCRIPTION	QTY
SX-SEV-30	SEVERO PILL CRUSHER	EACH
SX-MED-001	CRUSHER CUPS	2100 CUPS/CS
SX-MED-002	PLASTIC CUP COVERS	500 CUPS/CS
SX-MED-003	PLASTIC CRUSHING SLEEVES	2100/CS
MC-CUP1	PAPER CUPS 1 OZ	250/CS
SX-ML-01	METAL CUP	EACH
SX-SEV-037	METAL STABILIZING PLATE	EACH
SX-SEV-302	SEVERO SPARE CRUSHER	EACH



SILENT KNIGHT

The Silent Knight is a quiet and easy-to-use pill crusher that requires minimum force and prevents cross-contamination.

- Silent and will not disturb patients.
- Prevents cross-contamination, no cleanup necessary
- Requires minimum force to crush tablets

PROD. #	DESCRIPTION	QTY
RD-G601	SILENT KNIGHT	EACH
RD-G600	PILL CRUSHER BAGS	1000/CS





COMPOUNDING AND MIXING DEVICE

QUARTETRX Automated Oral Liquid Compounder

QuartetRx is the industry's first automated oral liquid compounding device that improves business volume and margins for pharmacies through compounding efficiency. QuartetRx can compound up to four medications simultaneously within 20 minutes using highly engineered, single-use containers and a wet milling process. It compounds oral liquid products and provides uniform dosing repeatedly and safely through improved product quality.

QuartetRx's core technology uses wet milling to reduce tablets or capsule contents to very small and uniform size particles. This process employs a specialized container with internal ribs (which perform the wet milling) and leads to smooth, palatable, and uniform dosing. This same compounding container is also used to store and dispense the product, eliminating the possibility of cross-contamination.



Enhanced safety for both pharmacist and patient



FUNCTIONS	SPECIFICATIONS
DIMENSION	13.6" (W) X 14.6" (D) X 13.0" (H)
WEIGHT	EMPTY 26.3 LB.
POWER	100 TO 240 VAC, 50 TO 60 HZ, MAXIMUM AMP USAGE 1.6 AMPS

ASK US!



Ask your local sales representative for a complete live demonstration and see how QuartetRx's core technology can help you in your daily process.



MEDIMIX™ AUTOMATED MIXER Chemo Vial Reconstitution

Mechanical device that rolls drug vials to dissolve the powder into solution. Ideal for large batch reconstitution of antibiotics. Gentle mixing to prevent breakdown of drug molecules.

PRODUCT #	DESCRIPTION	QTY
MC-MM100	TABLE TOP CHEMO VIAL RECONSTITUTION MIXER	EACH



LABELLING SOLUTIONS

PALP Ancillary Medication Labelling



Palp (pharmacy accessory label printer) is a turnkey unit-dose barcode labelling solution for ancillary medication packaging (i.e., ampoules, vials, oral syringes, nebulizers, inhalers, IV bags, creams, ophthalmics, etc.) to meet requirements for bedside medication verification (bmv) practice.

AUTO-WRAP® Syringe Labelling System

Auto-Wrap™ Syringe Labelling System produces a printed label and wraps it around a syringe in one single motion at the speed of up to twenty syringes per minute, regardless of syringe size.

Accommodates syringe sizes from 0.5mL up to 60mL without any need for adjustment or changing of parts. Works with any type of oral slip or injectable syringe. Open face design allows for easy loading of label stock and access to all controls.



SL-11510
1" X 1.5"
Print Area

SL-11515
1.5" X 1.5"
Print Area

SL-21512
1" X 1.25"
Print Area

FUNCTIONS	SPECIFICATIONS
DIMENSION	17.5" (W) X 7.5" (D) X 11.0" (H)
WEIGHT	25 LB.
POWER	115/230V, 50/60 Hz, 70 Watt
SAFETY	CE, NRTL (MET) US

LIQUIDOSE™ Labelling System

Liquidose labelling system is a tamper-evident sheet (1" x 2.87") that fit 15, 30, or 60ml vials; accommodates 5 lines of type, 30 characters per line.



PRODUCT #	DESCRIPTION	QTY
MD-LD120	CONTINUOUS FEED FORM: BLANK LABELS	1000/CS
MD-LD130	LASER/INKJET CUT-SHEET FEED	1000/CS





MEDICATION PACKAGING AND AUTOMATION

COMPOUNDING, LABELLING, AND PACKAGING SOLUTIONS

PACKAGING AND SEALING SOLUTIONS

MTS 350™ Single Dose Sealing Automation

Combining automated filling and sealing processes our MTS-350™ provides a versatile pre-pack solution for the medium volume pharmacy. The MTS-350™ has an optional label applicator or licence plate labelling system is available.

- Easy access for cleaning of heat plate if needed
- Dual timer for unit-dose and punch card sealing
- Motorized tablet filling system with adjustable speed and easy to change brushes
- Stainless steel and anodized aluminum construction allow for easy cleaning
- Tool-less changeover of the filling system
- Seal Station automatically opens when the cycle is complete
- Easy to read digital temperature controller
- Capable of filling a wide range of medications



AUTOGEN Single Dose Sealing Automation

The premier all electric (no air required) heat sealer. Simply plug the AutoGen into any standard 110 volt outlet to begin operation.

- Medical grade seal
- Whisper quiet operation
- Dual timer for unit-dose and punch card sealing
- Removable, height adjusting base plate



Safe and easy-to-use sealing mechanism



cUL Certified



Reliable technology



UNIT-DOSE PACKAGING

Heat Seal Blister Cards

Heat seal blister cards are required for most pre-pack and automated packaging solutions. Our line of heat seal blister punch cards include 30, 60, and 90 day cards, mealtime cards, trap door cards, 28 day cards, 14/15/16 dose cards.



Cold Seal Blister Cards

Cold seal blister cards are the ideal solution for pharmacies dealing with low volumes and heat sensitive medications. Cold seal cards can be used in compounding pharmacies where doses can change more frequently. They are easy to use and are available in a variety of sizes.

Control Drug Blister Cards

Healthmark "control drug" blister card is a twenty dose cold seal format that is easy to package, label, store, and dispense. No problems with heat sensitive medication. Card designed to minimize space requirement in nursing cabinets.

- No need for heated sealer
- Durable medical grade seal and tear resistant card stock
- Large size blister option for hydromorphone capsules



PROD. #	DESCRIPTION	QTY
MT-395-21	HEALTHMARK 20 DOSE CONTROL CARD	500/CS
MT-231-20S	BLISTERS (SMALL)	500/CS
MT-231-20L	BLISTERS (LARGE)	500/CS
MT-651-28	CORK PADDLE	EACH

CELLULOSE SELF-SEALING BANDS

Wet plastic bands that shrink tightly as they dry. Select appropriate size by measuring the diameter of cap times (x) the length of the cap down to the neck of the bottle. For child and non-child resistant caps.

- Provides additional package protection, multiples sizes.



MEDICATION PACKAGING AND AUTOMATION

COMPOUNDING, LABELLING, AND PACKAGING SOLUTIONS

PACKAGING AND SEALING SOLUTIONS

MEDI-DOSE® Blister Packaging System

Simple to learn and use manual blister packaging system for oral unit-dose solids. Ideal system for specialty use (i.e., control drugs, oncology or penicillin meds, heat resistant meds, large size meds, night cupboard, small runs, and much more) or full system for a small hospital.

- No machinery, no training required
- Easy press moisture resistant cold seal
- Various selections of lid labels and blister



Tamper-evident



Inexpensive, easy, and flexible

PRODUCT #	DESCRIPTION	QTY
MD-MD100	ROUND MEDI-CUP BLISTER SHEETS, CLEAR, 3/8" DEPTH (6MTHS)	5000/CS
MD-MD105	ROUND MEDI-CUP BLISTER SHEETS, NULTRAVIOLET AMBER, 3/8" DEPTH (6MTHS)	5000/CS
MD-MD115	ROUND MEDI-CUP BLISTER SHEETS, NULTRAVIOLET AMBER, DEEPER 11/16" CAPACITY (6MTHS)	2500/CS
MD-MD125	ROUND MEDI-CUP BLISTER SHEETS, NULTRAVIOLET AMBER, MINI 3/16" CAPACITY (6MTHS)	5000/CS
MD-MD135	ROUND MEDI-CUP BLISTER SHEETS, NULTRAVIOLET AMBER, JUMBO 1" CAPACITY (6MTHS)	2500/CS
MD-MD400	ROUND MEDI-CUP PLUS BLISTER SHEETS, BLUE, 3/8" DEPTH (1 YEAR DATING)	5000/CS
MD-MD405	ROUND MEDI-CUP PLUS BLISTER SHEETS, NULTRAVIOLET GREEN, 3/8" DEPTH (1YR)	5000/CS
MD-MD415	ROUND MEDI-CUP PLUS BLISTER SHEETS, NULTRAVIOLET GREEN, DEEPER 11/16" CAPACITY (1YR)	2500/CS
MD-MD425	ROUND MEDI-CUP PLUS BLISTER SHEETS, NULTRAVIOLET GREEN, MINI 3/16" CAPACITY (1YR)	5000/CS
MD-MD435	ROUND MEDI-CUP PLUS BLISTER SHEETS, NULTRAVIOLET GREEN, JUMBO 1" CAPACITY (1YR)	2500/CS
MD-MD #COLOUR	LASER LABEL "25" LID-LABEL COVERS FORMATTED FOR LASER & INK JET PRINTING, 12 COLOURS	2500/CS
MD-MD270	LID-LABEL COVERS "5" DIRECT THERMAL PRINTING	1000/CS
MD-MD550	LID-LABEL COVERS "5" ADD A FIVE, CONTINUOUS FEED	2500/CS
MD-MD925	CONTINUOUS FEED LID-LABEL COVER SHEET DISPENSER	EACH
MD-MD145	MEDI-CUP OVAL BLISTER SHEETS, NULTRAVIOLET AMBER, 3/8" DEPTH (6MTHS)	5000/CS
MD-MD445	MEDI-CUP PLUS OVAL BLISTER SHEETS, NULTRAVIOLET GREEN, 3/8" CAPACITY (1YR)	5000/CS
MD-MD455	MEDI-CUP PLUS OVAL BLISTER SHEETS, NULTRAVIOLET GREEN, DEEP 5/8" CAPACITY(1YR)	2500/CS
MD-MD200	LID-LABEL COVERS OVAL "25" SHEET FORM, BLUE	2500/CS
MD-MD9458	5/8" DEEP MULTI-PURPOSE BLISTERS (9 DOSES PER SHEET) 12 MONTH (GREEN, USP CLASS A)	100/CS
MD-MD9454	1-1/4" DEEP MULTI-PURPOSE BLISTERS (9 DOSES PER SHEET) 12 MONTH (GREEN, USP CLASS A)	100/CS
MD-MD18 #COLOUR	LASER LABEL LID-LABEL COVERS – MPB (9 DOSES PER SHEET), 12 COLOURS	100/CS

TAMPALERT® Tamper-Evident Liquid Packaging

Leak proof vials and unique tamper-evident seal. Simply screw cap on bottle. When the cap is removed, a tamper foil is in place protecting medication until removal.

- Child resistant or non-child resistant caps
- White, clear, or amber
- Sizes available from 15ml to 120ml



Perfect for controlled substances and legend drugs



In-house or outpatient dispensing applications

PRODUCT #	DESCRIPTION	QTY
TP-METH100	AMBER 100ML VIALS W/TAMPER EVIDENT CAP (6 CARTONS OF 108)	648/CS
MH-LML34-30ML	30ML PLASTIC TAMPER-EVIDENT BOTTLES	250/CS
MD-TA15	15ML NATURAL POLYETHYLENE VIAL	1000/CS
MD-TA15W	15ML WHITE POLYETHYLENE VIAL	1000/CS
MD-TA15C	15ML CHILD RESISTANT CAP	500/CS
MD-TA15CN	15ML NON-CHILD RESISTANT CAP	500/CS
MD-TA30	30ML NATURAL POLYETHYLENE VIAL	1000/CS
MD-TA30W	30ML WHITE POLYETHYLENE VIAL	1000/CS
MD-TA30C	30ML CHILD RESISTANT CAP	500/CS
MD-TA30CN	30ML NON-CHILD RESISTANT CAP	500/CS
MD-TA60	60ML NATURAL POLYETHYLENE VIAL	1000/CS
MD-TA60W	60ML WHITE POLYETHYLENE VIAL	1000/CS
MD-TA60C	60ML CHILD RESISTANT CAP	500/CS
MD-TA60CN	60ML NON-CHILD RESISTANT CAP	500/CS
MD-TA100	100ML NATURAL POLYETHYLENE VIAL	500/CS
MD-TA100W	100ML WHITE POLYETHYLENE VIAL	500/CS
MD-TA120	120ML NATURAL POLYETHYLENE VIAL	500/CS
MD-TA120W	120ML WHITE POLYETHYLENE VIAL	500/CS
MD-TA100C	100ML/120ML CHILD RESISTANT CAP	500/CS
MD-TA100CN	100ML/120ML NON-CHILD RESISTANT CAP	500/CS



PRESS-IN BOTTLE ADAPTERS

Withdraw oral liquid medications from standard stock bottles into oral syringes. Available in four sizes to fit standard plastic bottle openings with secure fit and accurate dosing with no spills. Fits TampAlert® unit dose containers.

- Low cost and leakproof

PRODUCT #	DESCRIPTION	QTY
MD-PBA20	20 MM	100
MD-PBA24	24 MM	100
MD-PBA28	28 MM	100
MD-PBA33	33 MM	100



SAFETY



ACCURACY



EFFICIENCY



RELIABILITY

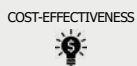

COST-EFFECTIVENESS



NAPRA COMPLIANT



SAFE FOR CHEMOTHERAPY



MEDICATION PACKAGING AND AUTOMATION

COMPOUNDING, LABELLING, AND PACKAGING SOLUTIONS

PACKAGING AND SEALING SOLUTIONS

NEOMED® Pharmacy Syringes

Neomed® pharmacy oral dispensers come in clear or amber. No machinery, no training required “oral only” sizing and labelling. Latex, dehp, and bpa free. The syringes display the metric scale (milliliters) for medication measurement.



PRODUCT #	DESCRIPTION	QTY
B-S05EO	CLEAR ORAL DISPENSERS, BLUE GRADIENT MARKINGS, 0.5ML	500/CS
BB-S1EO	CLEAR ORAL DISPENSERS, BLUE GRADIENT MARKINGS, 1ML	500/CS
BB-S3EO	CLEAR ORAL DISPENSERS, BLUE GRADIENT MARKINGS, 3ML	500/CS
BB-S6EO	CLEAR ORAL DISPENSERS, BLUE GRADIENT MARKINGS, 6ML	500/CS
BB-S12EO	CLEAR ORAL DISPENSERS, BLUE GRADIENT MARKINGS, 12ML	500/CS
BB-S20EO	CLEAR ORAL DISPENSERS, BLUE GRADIENT MARKINGS, 20ML	500/CS
BB-S35EO	CLEAR ORAL DISPENSERS, BLUE GRADIENT MARKINGS, 35ML	200/CS
BB-S60EO	CLEAR ORAL DISPENSERS, BLUE GRADIENT MARKINGS, 60ML	200/CS
BA-S05EO	AMBER ORAL DISPENSERS 0.5ML	500/CS
BA-S1EO	AMBER ORAL DISPENSERS 1ML	500/CS
BA-S3EO	AMBER ORAL DISPENSERS 3ML	500/CS
BA-S6EO	AMBER ORAL DISPENSERS 6ML	500/CS
BA-S12EO	AMBER ORAL DISPENSERS 12ML	500/CS
BA-S20EO	AMBER ORAL DISPENSER 20 ML	200/CS
BA-S35EO	AMBER ORAL DISPENSERS 35ML	200/CS
BA-S60EO	AMBER ORAL DISPENSERS 60ML	200/CS
NM-TC	SELF-RIGHTING ORAL SYRINGE TIP CAPS, NON-STERILE, ORANGE (125/PACK, 8P/CS)	1000/CS

TAMPER-EVIDENT ORAL SYRINGE CAPS

Tamper-evident oral syringe caps make tampering immediately evident when the coloured outer sleeve is broken or missing. Allows filled intact caps dispensers to be returned for recycling.

PRODUCT #	DESCRIPTION	QTY
II-57-70	TAMPER-EVIDENT ORAL SYRINGE CAPS WITH BAXA ORAL DISPENSERS	100/CS
II-57-75	TAMPER-EVIDENT CAP WITH NEOMED ORAL DISPENSERS	100/CS



OPHTHALMIC DROPPERS

Ophthalmic droppers for unit-dose eye preparations. Includes white caps and tips.

PRODUCT #	DESCRIPTION	QTY
AC-211631	3ML STERILE (12/PACK, 12P/CS)	144/CS
AC-211632	7ML STERILE (12/PACK, 12P/CS)	144/CS
AC-211633	15ML STERILE (12/PACK, 12P/CS)	144/CS
AC-211634	30ML STERILE (12/PACK, 12P/CS)	144/CS
MD-EPS211630S	3ML STERILE (50/PACK, 2P/CS)	100/CS
MD-EPS211632S	7ML STERILE (50/PACK, 2P/CS)	100/CS
MD-EPS211633S	15ML STERILE (50/PACK, 2P/CS)	100/CS
MD-SD10-3	3ML STERILE (10/PACK, 24P/CS)	240/CS
MD-SD10-7	7ML STERILE (10/PACK, 24P/CS)	240/CS
MD-SD10-10	10ML STERILE (10/PACK, 24P/CS)	240/CS
MD-SD10-15	15ML STERILE (10/PACK, 24P/CS)	240/CS
MD-EPS211630	3ML NON-STERILE	144/CS
MD-EPS211632	7ML NON-STERILE	144/CS
MD-EPS211633	15ML NON-STERILE	144/CS



AUTOSQUEEZE AND AUTODROP

Autodrop is a device that draws the user's gaze away while holding the lower lid gently in place.

Autosqueeze is a grip that clips around the eye drop bottle providing an ergonomic grip and extra leverage. By pressing the Autosqueeze, eye drops are successfully delivered on the first attempt, every time.

- Fits virtually all eye drop bottles
Can be used alone or connected

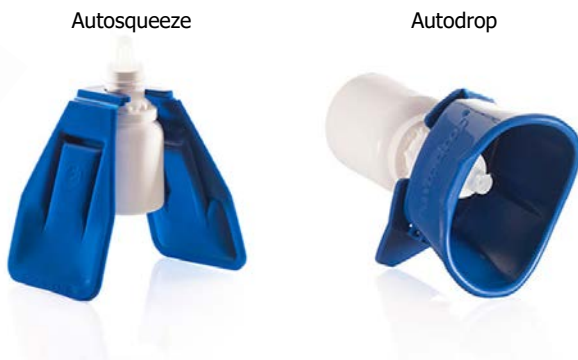



INVENTORY, DELIVERY, AND SAFETY SYSTEMS

COMPLETE INVENTORY MANAGEMENT SOLUTIONS

INVENTORY MANAGEMENT SYSTEM



INTELLIGUARD® LINKED VISIBILITY INVENTORY STATION™ (RFID)

The Intelliguard® Linked Visibility Inventory Station™ or LVIS™ is an intelligent and safe stocking solution. LVIS™ is offering a quick access for care teams while improving safety and control of the inventory.

Pharmacy teams get real-time visibility to inventory data in every room, every minute of every day; care workers enjoy simple access and confidence that the right medications will be available when and where needed.



Simultaneously unlocks drawers, records a start and end time and complete a reconciliation record



Anticipates shortages and sends proactive notifications throughout the day



INTELLIGUARD® INVENTORY MANAGEMENT SYSTEM (RFID)

The Intelliguard® inventory management system uses RFID technology to provide real-time visibility and reduce hospital inventory costs for high-value, critical dose pharmaceuticals.

- Controlled temperature cabinets available in four sizes
- Improved inventory management
- Identify shortages, avoiding stock-outs



INTELLIGUARD® KIT AND TRAY MANAGEMENT (RFID)

The Intelliguard® kit and tray management system uses advanced RFID technology to automate medication inventory management and replenishment while significantly reducing required work time.

- Touch screen user interface
- All-in-one cart
- Optimize the pharmacy technician and pharmacist time allocation



SLS SAFE LABEL SYSTEM

Codonics safe label system SLS500i, honoured for its innovation, is a complete solution to enhance healthcare by improving patient safety and labelling compliance in the operating room or anywhere syringes are prepared.

- Integrated administration tool
- 2d barcode on labels
- Visual and audible confirmations

BEACON™ Inventory and Workflow Management System

Beacon's breakthrough software, storage, and retrieval system transform your pharmacy into a superbly efficient storage and pick center, organizing all medication by activity, zones, and process. You now have stations to place your fastest moving inventory, as well as bulk compartments for slower moving medications. All parts of the Beacon control system use pick-to-light for rapid location dispensing.

At the touch of a button you can produce inventory, workflow, expired medication, and Will-Call Reports. Beacon helps you train your staff in half the time and verifies their steps throughout the entire fill and delivery process.



Better control on expired medication



Decrease fill time and footprint



Increasing the fill and inventory accuracy



SAFETY



ACCURACY



EFFICIENCY



RELIABILITY



COST-EFFECTIVENESS



NAPRA COMPLIANT



SAFE FOR CHEMOTHERAPY



INVENTORY, DELIVERY, AND SAFETY SYSTEMS

COMPLETE INVENTORY MANAGEMENT SOLUTIONS

STORAGE SOLUTIONS

HDSTOCK®

HDStock® provides a well-organized storage system while incorporating high-density storage capacity, easy access, and clear visibility. No other system offers you more storage in the same space and configures to your pharmacy's individual needs.

CORNER WORKSPACE



LARGE CAROUSEL



SMALL CAROUSEL



SPEED AND BULK SHELVING



WORKSTATIONS 1, 2, OR 3 BAY



CABINETS



ASK US!



Ask us for a preliminary custom design of your ideal pharmacy setup, from top to bottom. We will guide you in the selection of the right configuration according to your needs, no matter the size.



H+H TRAY STORAGE DIVIDING SYSTEM

This system increases the efficiency of drug trays and boxes suitable for all drawer types and sizes. To comply with safety standards, they are also available with locked or sealable lids. The trays can be quickly removed from the drawer and replaced.

H+H FLEX STORAGE AND DIVIDING SYSTEM

H+H SYSTEM's innovative, high-quality aluminium product is a flexible system that expands easily to different widths and depths. Combined with a wide range of accessories, this is a versatile storage system that satisfies all requirements.

The H+H FlexShelf is entirely compatible with the H+H ISO modular tray system. Shelf organization systems and drawers can also be fully integrated. You can even use modular tray systems by other manufacturers.



WELLSPOT™

Improving customer service through automated supply solutions. WellSpot™ stations provide convenient access to your customers, prescriptions on demand.



Convenience for patients

- Online tracking
- Biometric identification
- Touch screen interface
- On site convenient payment methods
- Barcode, credit card, RFID-enabled readers
- Automated patient notification system

Convenience for pharmacies

- Pharmacy system integration options
- Customizable design
- Search and seize
- HIPAA compliant data encryption
- Detailed inventory and activities reports
- Manages return to stock
- Touch screen display can generate ad revenue



CARTS AND MED HUBS

HI-CARE E

HI-CARE E is a state-of-the-art mobile power cart with patient medication storage drawers. HI-CARE E is perfect for bedside medication.

- Add/modify equipment as needed
- Unique interchangeable drawer system
- Powerful power-supply station, capable of running up to 11 hours

HI-PARADIGM E

HI-PARADIGM E is a point of care solutions designed to securely house the computer/scanning equipment needed for bedside medication scanning as part of advanced safety initiatives.

- Can be locked to secure your notebook/tablet
- Add/modify equipment as needed
- Unique interchangeable drawer system

HI-PINNACLE

HI-PINNACLE is a mobile power cart with patient large medication storage drawers. It is often used in long-term care and chronic/rehab settings or where there is a need for expanded medication requirements.

- Can be customized to meet your specific needs.
- Bifocal friendly
- Ergonomic steering and status indicator



HI-CARE E



HI-PARADIGM E



HI-PINNACLE

HI-CORE SERIES

The HI-CORE cart is lightweight, low-cost, and available in laptop and LCD versions. HI-CORE is also available in a non-powered or powered version.

- Configurable for use with different kinds of electronics devices
- The two-tier cabinet can be configured as needed
- Interlocking dividers included for all drawers

HI-SWIFT

The HI-SWIFT cart is an adjustable, lightweight cart that redefines mobility, with only 26 pounds. This cart is constructed with lightweight materials, including plastic and aluminum. Thanks to its design, HI-SWIFT does not have the tendency to tip, as some other carts do.

- Adjustable work surface for a wide range of notebooks
- Can be manually height-adjusted and locked into any positions
- Rear accessory mount compatible with the HI-CARE E and HI-CORE

ACCESSRX

Easy-to-use software, capacity for up to 12 individual patient drawers and advanced ergonomics provide the right solution for any facility looking to improve medication delivery.

- Individually locking bins/drawers for secure medication storage
- Nursing access to patient data at the bedside



HI-CORE SERIES



HI-SWIFT



ACCESSRX



CARTS AND MED HUBS

EMED SOLUTION MED HUBS CARTS

The med hubs cart, by Specialty Carts, offers a safe and secure emergency dose solution that optimizes operational efficiency and safety for nursing and pharmacy while controlling cost at the same time.

- Up to 360 secured medications locations
- Efficient management of lot number and expiration dates
- Tamper-evident packaging for safety during transportation



TRANSFER CARTS

Maximize efficiency and ease workflows by teaming Howard Medical Transfer carts with POC carts. Utilizing our interchangeable cassette system, Transfer carts make it possible for a full day's medications to be cassette-transferred securely from the pharmacy and stored in Med Hub units on patient floors.

When it's time for a med pass, nurses can transfer the medication-filled cassettes directly from the Med Hub to their POC carts for safe delivery to patient rooms.

MED HUB

The Med Hub, with its interchangeable drawer system and E-Comm Centralized Control Panel, is designed to provide secure, decentralized storage for nursing stations or small wards. When it's time for a Med pass, all your meds are there, no need for extra trips to the pharmacy.

Medication-filled bins can be switched easily from the Med Hub to POC carts and transported to patient rooms.



ACCESSCENTER

The new AccessCenter™ offers the features healthcare facilities need to accurately and efficiently manage medications, while providing value and a strong return on investment.

Whether you use a decentralized or centralized medication deliver model, the system fully supports your current medication management process with single-drug control as well as the capacity to increase medication availability, even IV solutions and bulk items.



ORAL LIQUID REPACKAGING

POTASSIUM CHLORIDE UNIT-DOSE ORAL LIQUID CUPS

Ready-to-use oral cups of potassium chloride unit dose

PROD. #	DESCRIPTION	QTY
HK-KCL075	7.5ML UNI-KCL ORAL UNIT-DOSE LIQUID (10MMOL)	144/CS
HK-KCL150	15ML UNI-KCL ORAL UNIT-DOSE LIQUID (20MMOL)	144/CS
HK-KCL300	30ML UNI-KCL ORAL UNIT-DOSE LIQUID (40MMOL)	80/CS



SEAFORD LIQUID MULTIVITE™ High Potency Liquid Multi-Vitamin/Mineral Formulation

Seaford Liquid Multivite™ is to be used as a nutritive adjunct when poor appetite compromises dietary intake in multiple situations, such as dehydration.

- Contains no iron, sugar, or alcohol (i.e., no constipation, diabetic, or toxicity issues)
- Especially formulated for hospital use by leading Canadian nutritional experts
- A convenient and economical alternative to tablet crushing
- Pleasant orange flavour

PRODUCT #	DESCRIPTION	QTY
SF-MV240	HIGH POTENCY LIQUID MULTI-VITAMIN/MINERAL, 240 ML	12/CS

DOSES	INGREDIENTS
5000 I.U.	VITAMIN A (RETINOL)
4.5 MG	VITAMIN B1 (THIAMINE)
3 MG	VITAMIN B2 (RIBOFLAVIN)
20 MG	VITAMIN B3 (NIACIN)
6 MG	VITAMIN B5 (CALCIUM D-PANTOTHENATE)
2 MG	VITAMIN B6 (PYRIDOXINE HYDROCHLORIDE)
150 MG	VITAMIN C (ASCORBIC ACID)
400 I.U.	VITAMIN D3
200 I.U.	VITAMIN E (D-ALPHA-TOCOPHEROL)
100 MCG	BIOTIN
199 MCG	FOLIC ACID
55 MCG	SELENIUM
12 MG	ZINC





SALINE, SODIUM CITRATE AND HEPARIN SYRINGES

PRAXIJECT™ SALINE **Sodium chloride 0.9%** **Sterile Field Compatible**



The syringes are packaged in sterile peel pouch for use anywhere in the hospital, including sterile field applications. Praxiject™ is the only 20ml saline prefilled syringe on the market, allowing a more turbulent flush.

- Zero reflux
- 24 month expiry dating
- Preservative free, latex free

PRODUCT #	DESCRIPTION	QTY
MR-37053	SALINE, 3ML OF 0.9% SODIUM CHLORIDE IN A 10ML SYRINGE. SF	100/CS
MR-3705C	SALINE, 10ML OF 0.9% SODIUM CHLORIDE IN 10ML SYRINGE. SF	100/CS
MR-3706	SALINE, 20ML OF 0.9% SODIUM CHLORIDE IN 20ML SYRINGE. SF	60/CS

ZR® BRAND SALINE **Sodium chloride 0.9%** **Sterile Path**



- Terminally sterilized fluid pathway
- Zero reflux
- 24 month expiry dating

PRODUCT #	DESCRIPTION	QTY
EX-S3	SALINE, 2.5ML OF 0.9% SODIUM CHLORIDE IN A 3ML SYRINGE	100/CS
EX-10031	SALINE, 3ML OF 0.9% SODIUM CHLORIDE IN A 10ML SYRINGE	100/CS
EX-S510	SALINE, 5ML OF 0.9% SODIUM CHLORIDE IN A 10ML SYRINGE	100/CS
EX-S10	SALINE, 10ML OF 0.9% SODIUM CHLORIDE IN A 10ML SYRINGE	100/CS

CITRAFLOW™ **Sodium citrate 4%** **Sterile Field Compatible**



Ready-to-use Sodium Citrate 4% prefilled syringes, the natural way to lock catheters. Available in a convenient twin pack* for dual lumen catheter locking. Citraflow™ is a safe alternative to heparin.

- The 3 ml fill volume enhances best clinical practice.
- 30 month expiry dating

PRODUCT #	DESCRIPTION	QTY
MR-38543-1	3ML 4% SODIUM CITRATE SOLUTION USP IN A 5ML SYRINGE. SF TWIN PACK *	200/CS
MR-38553	3ML 4% SODIUM CITRATE SOLUTION USP IN A 10ML SYRINGE. SF	100/CS
MR-3854	5ML 4% SODIUM CITRATE SOLUTION USP IN A 5ML SYRINGE. SF	120/CS

CITRAFLOWPLUS™
Sodium Citrate 4% w/Ethanol 30%
Sterile Field Compatible



CitraFlowPLUS™ combines in one syringe the anticoagulant properties of sodium citrate PLUS the antimicrobial properties of ethanol. This solution combination prevents biofilm formation, reduces incidences of CRBSI (catheter related blood stream infections) and is a safe alternative to heparin.

PRODUCT #	DESCRIPTION	QTY
MR-38453	3ML SODIUM CITRATE 4% AND ETHANOL 30% IN A 10ML SYRINGE. SF	100/box

HEPARIN LOCK/FLUSH
Sterile Path



Low dose heparin prefilled syringes in 100 units/mL and 10 units/mL for heparin lock/flush applications.

PRODUCT #	DESCRIPTION	QTY
EX-HH5	5ML HEPARIN IN A 10ML SYRINGE	100/CS
EX-HT5	5ML HEPARIN IN A 10ML SYRINGE	10/CS



WE GO ABOVE AND BEYOND TO SERVE YOU!

Delivering an unbeatable customer experience is at the centre of everything we do, every day! Our customer service team and experienced sales force are here to respond to your needs.

Healthmark has an excellent reputation for providing products that offer innovative, safety-oriented, and cost-effective solutions.

We strive to always find the best possible options for our customers.



CONTACT OUR CUSTOMER SERVICE TEAM

Toll free | 1-800-665-5492
Email | info@healthmark.ca
Fax | 514-336-7111

CATALOGUE V.201906

